



 **LA VALVULA**  
CONSUMIBLES PARA TECNICENTROS

CATÁLOGO





LA VALVULA es una empresa familiar que inició sus operaciones en el año 2011, al ver la necesidad de abastecer de insumos de vulcanización y herramientas propias del uso automotriz. La Válvula tiene como fin, proveer de insumos y herramientas a tecnicentros, distribuidores de llantas y vulcanizadores, las líneas de productos ofertados se han ido incrementando, actualmente manejamos alrededor de 400 ítems.



# INDICE

	PAG.
<b>Válvulas</b>	Auto - Camioneta..... 1-2
	Camión..... 2-3
	Empaques..... 3
	Industrial, otr, agrícola..... 3-4
	Motocicleta..... 4
	Gusanillos..... 5
	Extensiones de Válvulas..... 5
	Capuchones y tapas..... 6-8
	Herramientas..... 8-9
	TPMS..... 10-11
<b>Parches y reparos</b>	Parches para tubo (Flexibles)..... 12
	Parches universales para neumáticos..... 13
	Parches radiales para neumáticos..... 13-14
	Parches diagonales para neumáticos..... 14-15
	Parches diagonales lateral para neumáticos..... 15-16
	Pegantes, Selladores, Cojin..... 16-17
	Pasta de montaje, Crayones, Mechas..... 18
	Herramientas, Piedras y pastas..... 18-22
<b>Alineación y balanceo</b>	Pesa de vincha delgada..... 23
	Pesas de vincha gruesa..... 24
	Pesas de hierro gruesa y delgada..... 25
	Pesas para camión..... 26-27
	Pesas para camioneta..... 28
	Pesas adhesivas..... 28-29
	Martillos para pesas..... 29-30
	Pernos excéntricos..... 30-31
	Lainas..... 31
Herramientas para alinear y balancear..... 32	
<b>Tuercas y pernos</b>	Tuercas Normales..... 33-34
	Tuercas Especiales..... 35
	Tuercas de seguridad..... 35-36
	Pernos Normales..... 36
	Pernos Especiales..... 36
	Pernos de Seguridad..... 37
	Llaves Hexagonales..... 37-38
	Separadores y centradores..... 38-39
	Herramientas..... 39
Tuercas de aluminio..... 39	

# INDICE

	PAG.
<b>Milton</b>	Acoples y Conectores..... 40-41
	Reductores..... 41
	Infladores..... 42
	Medidores..... 43-44
	Pulverizadores..... 44
	Empaques..... 44
	Mangueras..... 45-47
<hr/>	
<b>Dados y pistolas de impacto</b>	Pistolas de impacto..... 48-50
	Mantenimiento y limpieza..... 50
	Dados de impacto..... 51-55
	Filtro lubricador..... 55
<hr/>	
<b>Aire y medición</b>	Medidores de profundidad..... 56
	Infladores de aire..... 56
	Inchadores de aire..... 57
	Medidores de aire..... 57
<hr/>	
<b>Llaves de rueda</b>	Llaves de rueda..... 58-60
	Extenciones de llave de rueda..... 60
<hr/>	
<b>Mangueras</b>	Mangueras..... 61-63
	Repuestos..... 63

# INDICE

	PAG.
<b>Montaje y desmontaje</b>	Palancas de montaje y desmontaje..... 64
	Palancas continentales..... 65
	Palancas de fuerza..... 66
	Palancas destalonadoras..... 66
	Tanques entalonadores..... 66
	Comprimidor de resortes..... 67
Destalonadores de llantas manual..... 67	
<b>Gatas</b>	Gatas tipo lagarto..... 68
	Gatas tipo botella..... 69
	Gatas tipo tijera..... 69
	Soportes para auto y camión..... 70
<b>Relabradoras</b>	Marcador de llantas..... 71
	Letras..... 71
	Relabradoras..... 72
	Cuchillas..... 72

Pesas de balanceo  
con **vincha** para  
todo tipo de  
**Vehículo.**

Podras encontrar todo tipo  
de pesas en la pagina **23.**



# BUFFALO

Pesas de balanceo  
**adhesivas** para  
todo tipo de  
**Vehículo.**

Podras encontrar todo tipo  
de pesas en la pagina **28.**



[www.lavalvula.com.ec](http://www.lavalvula.com.ec)

@lavalvulaec





## Programación de Sensores **T.P.M.S.** Para todo Vehículo

si necesitas sensores T.P.M.S.  
En la pagina **10** encontraras  
variedad de sensores.

ATEQ VT56  
VEHICLE MAKE/MODEL/YEAR  
33.3 32.8 Press to trigger sensor  
29.0

ID	PSI	Mhz	°F	BAT
LF 1E1C30E1	33.3	315	62	OK
RF 1E1C30E4	32.8	315	62	OK
RR 1E1C4228	33.3	315	59	OK
LR 1E1D5AE5	29.0	315	57	OK

Tx Fail Pass







# TPMS018 TPMS UNIVERSAL

Sensor TPMS para todo tipo de vehículo Asiaticos, Europeos, Americanos.  
Sensor de presion de llantas, monitorea la presion de tus llantas en todo momento.  
Maneja con total seguridad y tranquilidad.



[www.lavalvula.com.ec](http://www.lavalvula.com.ec)

@lavalvulaec



# VÁLVULAS Y TPMS



[www.lavalvula.com.ec](http://www.lavalvula.com.ec)

@lavalvulaec



øD x Lmm.

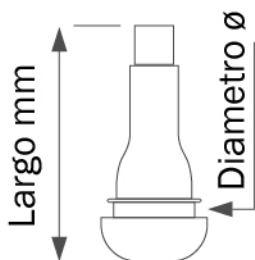

øD x Lmm X G° .

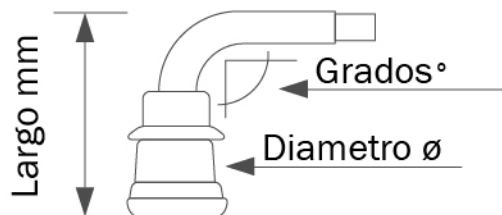

**Código: VAC001**

Válvula TR413.  
ø15 x 42.5 mm.  
REF.: 100u/pack



**Código: VAC002**

Válvula TR414.  
ø15 x 48.5 mm.  
REF.: 100u/pack



**Código: VAC003**

Válvula TR415.  
ø19.2 x 42.5 mm.  
REF.: 100u/pack



**Código: VAC011**

Válvula TR412.  
ø15 x 33 mm.  
REF.: 100u/pack



**Código: VAC004**

Válvula cromada TR413 AC.  
ø15 x 42.5 mm.  
REF.: 100u/pack



**Código: VAC016**

Válvula cromada TR413 C.  
ø15 x 42.5 mm.  
REF.: 100u/pack



**Código: VAC006**

Válvula TR413 AC-B.  
ø15 x 42.5 mm.  
REF.: 100u/pack



**Código: VAC007**

Válvula TR413 AC-R.  
ø15 x 42.5 mm.  
REF.: 100u/pack



**Código: VAC005**

Válvula TR413 AC-Y.  
ø15 x 42.5 mm.  
REF.: 100u/pack



**Código: VAC015**

Válvula TR413 AC-P.  
ø15 x 42.5 mm.  
REF.: 100u/pack



**Código: VAC014**

Válvula TR413 AC-G.  
ø15 x 42.5 mm.  
REF.: 100u/pack



**Código: VAC008**

Válvula TR414 AC-Y.  
ø15 x 48.5 mm.  
REF.: 100u/pack



**Código: VAC009**

Válvula metálica V5.  
ø14 x 48 mm.

REF.: 50u/pack



**Código: VAC013**

Válvula metálica V3.  
ø14 x 33 mm.

REF.: 100u/pack



**Código: VAC017**

Válvula TV25AL.  
ø15 x 25mm X 84°.

REF.: 1u/pack



**Código: VAC010**

Kit válvula invisible V007.  
ø11.5 - 16 x 24 mm.

REF.: 4u/pack



**Código: VCA001**

Válvula pequeña TR435.  
ø19 x 34 mm

REF.: 10u/pack



**Código: VCA002**

Válvula TR500 aro artillero.  
ø19 x 55 mm

REF.: 10u/pack



**Código: VCA003**

Válvula curva TR572-27.  
ø19 x 100 mm X 90°.

REF.: 50u/pack



**Código: VCA004**

Válvula TR573 aro artillero.  
ø19 x 115 mm

REF.: 50u/pack



**Código: VCA006**

Válvula V320-4.  
ø16 x 90 mm X 27°.

REF.: 50u/pack



**Código: VCA007**

Válvula V320-4 cromada.  
ø16 x 90 mm X 27°.

REF.: 50u/pack



**Código: VCA008**

Válvula V320-6.  
ø16 x 115 mm X 27°.

REF.: 50u/pack



**Código: VCA011**

Válvula curva AB1390.  
ø16 x 50 mm X 45°.

REF.: 50u/pack



**Código: VCA014**

Válvula TR 602-HP.  
ø12.4 x 61.3 mm

REF.: 10u/pack



**Código: VCA015**

Válvula TR 802-HP.  
ø17 x 66 mm

REF.: 10u/pack

**Código: VCA016**

Válvula cromada TR543C.  
 ø 16 x 35 mm X 45°

REF.: 10u/pack

**Código: VCA017**

Válvula curva TR570C-90.  
 ø19 x 84 mm X 90°.

REF.: 10u/pack

**Código: VCA018**

Válvula MS70-7.  
 ø 16 x 72 mm X 5°.

REF.: 10u/pack

**Código: VCA019**

Válvula TR573c-90.  
 ø 19 x 115 mm X 90°.

REF.: 10u/pack

**Código: VCA020**

Válvula cromada 555D.  
 ø 16 x 92 mm X 75°.

REF.: 10u/pack

**Código: EMP006**

Empaque TR572-573 grueso.

REF.: 50u/pack

**Código: EMP007**

Empaque V3.20.2-3-4-5-6 delgado.

REF.: 50u/pack

**Código: VEC001**

Válvula TR218A.  
 ø 27 x 55 mm.

REF.: 10u/pack

**Código: VEC002**

Válvula TR220A.  
 ø 35.5 x 72 mm.

REF.: 10u/pack

**Código: VEC003**

Válvula TR618A.  
 ø 22.5 x 30 mm.

REF.: 10u/pack

**Código: VEC014**

Válvula TR618.  
 ø 22.5 x 56 mm.

REF.: 10u/pack





**Código: VEC004**

Válvula curva larga TR621A.  
ø 22.5 x 93 mm X 65°.

REF.: 10u/pack



**Código: VEC006**

Válvula TRJ650-03.  
ø 31 x 79 mm X 80°.

REF.: 10u/pack



**Código: VEC008**

Válvula TRJ670-03.  
ø 22.5 x 64 mm.

REF.: 10u/pack



**Código: VEC007**

Válvula TRJ652-03.  
ø 31 x 140 mm X 80°.

REF.: 50u/pack



**Código: VEC016**

Válvula pequena TR416.  
ø18.5 x 40 mm

REF.: 50u/pack



**Código: VCA001**

Válvula pequena TR435.  
ø19 x 34 mm

REF.: 10u/pack



**Código: VMT001**

Válvula PVR70 90.  
ø20 x 32 mm X 90°.

REF.: 10u/pack



**Código: VMT002**

Válvula TR430A.  
ø14 x 33 mm.

REF.: 10u/pack



**Código: VMT005**

Válvula cromada VS8-45.  
ø16 x 53 mm X 45°.

REF.: 10u/pack



**Código: VMT006**

Válvula cromada VAMD-161.  
ø16 x 34.5 mm.

REF.: 10u/pack



**Código: VMT007**

Válvula cromada VS8-90.  
ø16 x 63 mm X 90°.

REF.: 10u/pack



**Código: VMT008**

Válvula PVR50 para scooter y moto  
ø12 x 34 mm X 90°.

REF.: 10u/pack

**ACOPLE MILTON 715BK**  
**Código: ACP001**

REF.: 1u/pack

Acople rapido Milton de 1/4"  
Más en la pagina 50.



**Código: GUS001**

Gusanillo 9002 para válvulas de auto y camioneta.

REF.: 100u/pack

**Código: GUS002**

Gusanillo TRJ650-03 para válvulas OTR.

REF.: 10u/pack

**Código: GUS003**

Adaptador de válvula macho.

REF.: 10u/pack

**Código: GUS004**

Adaptador de válvula hembra.

REF.: 10u/pack

**Código: EXT001**

Extensión de 10cm de largo cromada.

REF.: 10u/pack

**Código: EXT002**

Extensión de 11.5cm de largo cromada.

REF.: 10u/pack

**Código: EXT003**

Extensión de 13cm de largo cromada.

REF.: 10u/pack

**Código: EXT004**

Extensión de 14cm de largo cromada.

REF.: 10u/pack

**Código: EXT012**

Extensión plastica de 20cm rígida.

REF.: 10u/pack

**Código: EXT006**

Extensión flexible de 20cm metálica roja con soporte.

REF.: 10u/pack

**Código: EXT007**

Extensión flexible de 25cm metálica.

REF.: 10u/pack

**Código: EXT005**

Extensión flexible de 21cm negra con soporte.

REF.: 10u/pack

**VÁLVULA TR413 AC GT**  
**Código: VAC004**

REF.: 100u/pack  
 Válvula cromada para auto y camioneta.





**Código: CAS001**

Capuchón cromado.

REF.: 50u/pack



**Código: TAP001**

Tapa de válvula cromada.

REF.: 50u/pack



**Código: CAS002**

Capuchón azul.

REF.: 50u/pack



**Código: TAP002**

Tapa de válvula azul.

REF.: 50u/pack



**Código: CAS003**

Capuchón rojo.

REF.: 50u/pack



**Código: TAP003**

Tapa de válvula roja.

REF.: 50u/pack



**Código: CAS004**

Capuchón amarillo.

REF.: 100u/pack



**Código: TAP004**

Tapa de válvula amarilla.

REF.: 50u/pack



**Código: CAS005**

Capuchón verde.

REF.: 50u/pack



**Código: TAP005**

Tapa de válvula verde.

REF.: 50u/pack



**Código: CAS006**

Capuchón morado.

REF.: 50u/pack



**Código: TAP006**

Tapa de válvula morada.

REF.: 50u/pack



**Código: TAP007**

Tapa de válvula plástica negra.

REF.: 100u/pack



**Código: TAP008**

Tapa de válvula cromada nitrógeno.

REF.: 100u/pack



**Código: TAP009**

Tapa de válvula aluminio plateada.

REF.: 100u/pack

**Código: TAP010**

Tapa de válvula aluminio azul.

REF.: 100u/pack

**Código: TAP011**

Tapa de válvula aluminio roja.

REF.: 100u/pack

**Código: TAP012**

Tapa de válvula aluminio amarilla.

REF.: 100u/pack

**Código: TAP013**

Tapa de válvula aluminio Negro.

REF.: 100u/pack

**Código: TAP020**

Kit tapa de válvula pequeña Chevrolet.

REF.: 4u/pack

**Código: TAP021**

kit tapa de válvula pequeña Hyundai.

REF.: 4u/pack

**Código: TAP022**

kit tapa de válvula pequeña Kia.

REF.: 4u/pack

**Código: TAP023**

Kit tapa de válvula pequeña Mazda.

REF.: 4u/pack

**Código: TAP024**

Kit tapa de válvula pequeña Nissan.

REF.: 4u/pack

**Código: TAP025**

Kit tapa de válvula pequeña Toyota.

REF.: 4u/pack

**Código: TAP026**

Kit tapa de válvula pequeña Volkswagen.

REF.: 4u/pack

**Código: TAP027**

Kit tapa de válvula pequeña Ford.

REF.: 4u/pack

**Código: TAP030**

Kit tapa grande de válvula Momo roja.

REF.: 4u/pack



**Código: TAP031**

Kit tapa grande de válvula Momo negro.  
REF.: 4u/pack



**Código: TAP032**

Kit tapa grande de válvula Ferrari roja.  
REF.: 4u/pack



**Código: TAP033**

Kit tapa grande de válvula Ferrari negra.  
REF.: 4u/pack



**Código: TAP034**

Kit tapa grande de válvula Sparco azul.  
REF.: 4u/pack



**Código: TAP035**

Kit tapa grande de válvula BMW azul.  
REF.: 4u/pack



**Código: TAP036**

Kit tapa grande de válvula 500 amarilla.  
REF.: 4u/pack



**Código: TAP037**

Kit tapa grande de válvula WRC amarilla.  
REF.: 4u/pack



**Código: LEX004**

Llave pescadora de válvulas.

REF.: 1u/pack

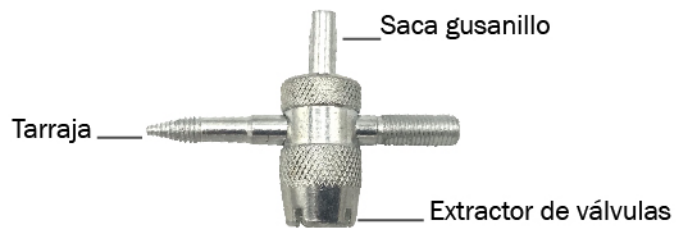

**Código: TAR001**

Tarraja tres en uno. Tarraja, saca gusanillo y extractor de válvula.

REF.: 1u/pack

**PERNOS Y TUERCAS**

Pernos y tuercas de seguridad, especiales y normales para todo tipo de aros.  
más información en la página 31



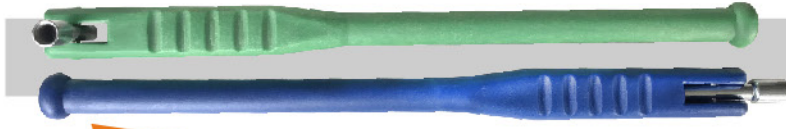

**Código: LEX001**

Llave plastica extractora de válvulas color verde y azul.

REF.: 1u/pack



Llave azul incluye saca gusanillos.



**Código: LEX003**

Llave metalica extractora de válvulas con caucho.

REF.: 1u/pack



Caucho protector para aros.



**Código: HRM017**

Saca gusanillo reforzado.

REF.: 1u/pack



**Código: HRM001**

Saca gusanillo doble lado para gusanillos normales y OTR.

REF.: 1u/pack



**Código: HRM002**

Saca gusanillo corto de 10cm.

REF.: 1u/pack



**Código: HRM003**

Saca gusanillo largo de 17cm.

REF.: 1u/pack

## KIT DECODIFICADOR TPMS

Decodificador tpms ATEQ  
 OBD2  
 Cable de red para conexión  
 Cable usb cargador  
 Cd driver para pc



**Código: TPMS001**

Sensor + válvula tpms Ford f150 2010-2016.

REF.: 1u/pack



**Código: TPMS002**

Sensor + válvula tpms Ford 35 f150 2015-2022.

REF.: 1u/pack



**Código: TPMS010**

Sensor + válvula tpms universal Toyota lexus pa1-014.

REF.: 1u/pack



**Código: TPMS011**

Sensor + válvula tpms Ford F150 2010-2014.

REF.: 1u/pack



**Código: TPMS012**

Sensor + válvula tpms Schader ez-sensor 33500.

REF.: 1u/pack



**Código: TPMS013**

Sensor + válvula tpms Great Wall Wingle 7 2019-2022.

REF.: 1u/pack



**Código: TPMS014**

Sensor + válvula tpms Toyota Lexus.

REF.: 1u/pack



**Código: TPMS015**

Sensor + válvula tpms Jac motors.

REF.: 1u/pack



**Código: TPMS016**

Sensor + válvula tpms  
Haval H6.  
REF.: 1u/pack



**Código: TPMS017**

Sensor + válvula tpms  
Haval h7/h9.  
REF.: 1u/pack



**Código: TPMS018**

Sensor + válvula tpms  
UNIVERSAL.  
REF.: 1u/pack



**Código: TPMS020**

Válvula tpms tr413  
Schrader ford.  
REF.: 1u/pack



**Código: TPMS028**

Válvula tpms tr413-2  
para sensor.  
REF.: 1u/pack



**Código: TPMS029**

Válvula tpms tr413-3  
para sensor.  
REF.: 1u/pack



**Código: TPMS021**

Válvula 14 auto.  
REF.: 1u/pack



**Código: TPMS022**

Válvula tpms alligator Snap-in  
valve clip-pin.  
REF.: 1u/pack



**Código: TPMS024**

Válvula 12 auto.  
REF.: 1u/pack



**Código: TPMS025**

Válvula tr413 Ford original.  
REF.: 1u/pack



**Código: TPMS026**

Válvula 10 f-150 aluminio.  
REF.: 1u/pack



**Código: TPMS023**

Válvula tpms camión cromada.  
REF.: 1u/pack



**Código: TPMS027**

Válvula cromada tpms-11  
base redonda.  
REF.: 1u/pack



## DECODIFICADOR TPMS

Diagnostica, activa y programa TPMS80 es compatible con el 98% de marcas Americanas, Europeas y Asiaticas.

**NUEVO**



**BUFFALO**



**MILTON**

- **Medidores de aire**
- **Acoples**
- **Conectores**
- **Infladores**
- **Lubricantes**
- **Reductores**

**PAGINA 39**

# PARCHES Y PEGAS



**VIPAL**  
REPAROS PARA CÁMARA DE AIR  
INNER TUBE REPAIRS  
PARCHES PARA CÁMARA DE AIR  
RAPPREZZI PER RIPARAZIONI DI GOMME D'ARIA  
EMPLATS DE REPARATION POUR CHAMBRES  
À AIR  
FÜGKLEBEN FÜR REIFENKÄMME  
www.levulva.com.ec  
@lavalvulaec  
f i







**Código: PVI043**

Parche flexible R00.  
ø30mm.

REF.: 100u/pack



**Código: PVI001**

Parche flexible R01.  
ø40mm.

REF.: 100u/pack



**Código: PVI002**

Parche flexible R02.  
ø50mm.

REF.: 40u/pack



**Código: PVI003**

Parche flexible R03.  
ø60mm.

REF.: 40u/pack



**Código: PVI004**

Parche flexible R04.  
ø80mm.

REF.: 40u/pack



**Código: PVI005**

Parche flexible R05.  
ø100mm.

REF.: 25u/pack



**Código: PVI006**

Parche flexible R06.  
ø120mm.

REF.: 25u/pack



**Código: PVI022**

Parche universal RT-3.  
ø60mm.

REF.: 40u/pack

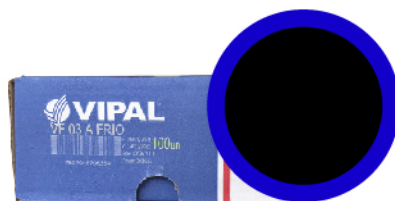

**Código: PVI023**

Parche universal VF03.  
ø35mm.

REF.: 100u/pack



**Código: PVI024**

Parche universal VF06.  
50 X 50 mm.

REF.: 50u/pack



**Código: PVI025**

Parche universal VF08.  
67 X 67 mm

REF.: 50u/pack



**Código: PVI007**

Parche radial RAC10.  
77x55mm.

REF.: 20u/pack

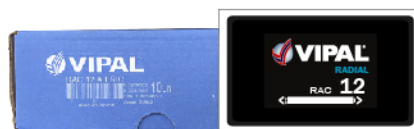

**Código: PVI008**

Parche radial RAC12.  
115x70mm.

REF.: 10u/pack



**Código: PVI009**

Parche radial RAC14.  
130x85 mm.

REF.: 10u/pack



**Código: PVI010**

Parche radial RAC15.  
90x75mm.

REF.: 20u/pack



**Código: PVI011**

Parche radial RAC20.  
120x80mm.

REF.: 10u/pack



**Código: PVI012**

Parche radial RAC22.  
165x75 mm.

REF.: 10u/pack



**Código: PVI013**

Parche radial RAC24.  
215x75mm.

REF.: 10u/pack



**Código: PVI014**

Parche radial RAC25.  
125x115mm.

REF.: 10u/pack



**Código: PVI015**

Parche radial RAC26.  
260x75 mm.

REF.: 10u/pack

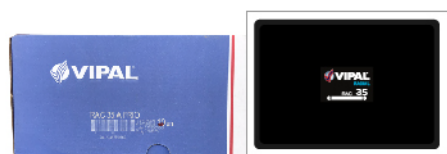

**Código: PVI016**

Parche radial RAC35.  
180x130mm.

REF.: 20u/pack



**Código: PVI017**

Parche radial RAC40.  
200x100mm.

REF.: 10u/pack

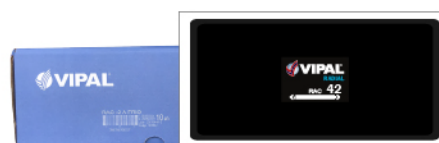

**Código: PVI018**

Parche radial RAC42.  
260x130 mm.

REF.: 10u/pack



**Código: PVI019**

Parche radial RAC44.  
335x130mm.

REF.: 20u/pack



**Código: PVI020**

Parche radial RAC45.  
230x180mm.

REF.: 5u/pack



**Código: PVI021**

Parche radial RAC46.  
440x180 mm.

REF.: 5u/pack



**Código: PVI026**

Parche diagonal VD01.  
ø60mm.

REF.: 30u/pack



**Código: PVI027**

Parche diagonal VD02.  
ø85mm.

REF.: 20u/pack



**Código: PVI028**

Parche diagonal VD03.  
105 mm.

REF.: 10u/pack



**Código: PVI029**

Parche diagonal VD04.  
135mm.

REF.: 10u/pack



**Código: PVI030**

Parche diagonal VD05.  
165mm.

REF.: 10u/pack



**Código: PVI031**

Parche diagonal VD06.  
245 mm.

REF.: 10u/pack



**Código: PVI032**

Parche diagonal VD07.  
300mm.

REF.: 10u/pack



**Código: PVI033**

Parche diagonal VD08.  
350mm.

REF.: 5u/pack



**Código: PVI034**

Parche diagonal VD09.  
395 mm.

REF.: 5u/pack



**Código: PVI035**

Parche diagonal VD10.  
455mm.

REF.: 3u/pack



**Código: PVI026**

Parche diagonal lateral VDL05.  
165mm.

REF.: 10u/pack



**Código: PVI027**

Parche diagonal lateral VDL06.  
245mm.

REF.: 10u/pack



**Código: PVI028**

Parche diagonal lateral VDL07.  
300 mm.

REF.: 10u/pack



**Código: PVI013**

Parche diagonal lateral VDL08.  
350mm.

REF.: 10u/pack



**Código: PVI014**

Parche diagonal lateral VDL09.  
395mm.

REF.: 5u/pack



**Código: PVI015**

Parche diagonal lateral VDL10.  
455 mm

REF.: 3u/pack



**Código: PEG003**

cemento vipal universal CV00.  
lata de 163g / 5.74oz.

REF.: 1u/pack



**Código: PEG013**

Vulcanizante CV00-B.  
lata de 171g / 6.03oz.

REF.: 1u/pack



**Código: PEG004**

cemento vipal universal CV01.  
lata de 362g / 12.76oz.

REF.: 1u/pack



**Código: PEG014**

Vulcanizante vipal CV01-B.  
lata de 380g / 13.40oz.

REF.: 20u/pack



**Código: PEG012**

cemento vipal universal CV02.  
lata de 725g / 25.57oz.

REF.: 5u/pack



**Código: PEG015**

Vulcanizante CV02-B.  
Lata de 760g / 26.80oz.

REF.: 5u/pack



**Código: PEG001**

Pega vipal BV-02.  
tubo de 18g / 0.63oz.

REF.: 12u/pack



**Código: PEG002**

Pega vipal BV-03.  
tubo de 32g / 1.12oz.

REF.: 6u/pack



**Código: PEG010**

Sellador vipal SV-01E.  
lata de 400g / 14.11oz.

REF.: 1u/pack



**Código: PEG016**

Sellador vipal SV-02E.  
lata de 400g / 14.11oz.

REF.: 1u/pack



**Código: PEG009**

Pega COLA VULK.  
lata de 685g / 24.16oz.

REF.: 1u/pack



**Código: PEG021**

Pega COLA VULK.  
lata de 14kg / 30.80lb.

REF.: 1u/pack



**Código: PEG017**

Pega VIPAFIX.  
lata de 1000g / 2.20lb.

REF.: 1u/pack



**Código: PEG019**

Diluyente BUPPAL E.  
lata de 1000ml / 33.00oz.

REF.: 1u/pack



**Código: PEG024**

BULPAL en espray.  
lata de 400ml.

REF.: 1u/pack



**Código: PEG018**

Catalizador VIPAFIX 30min.  
50ml / 1.6oz.

REF.: 10u/pack



**Código: PEG019**

Catalizador VIPAFIX 60min.  
25ml / 0.8oz.

REF.: 10u/pack



**Código: COJ001**

Cojin vipal MB/AC 10k.  
3000 x 23.5 cm.

REF.: 1u/pack

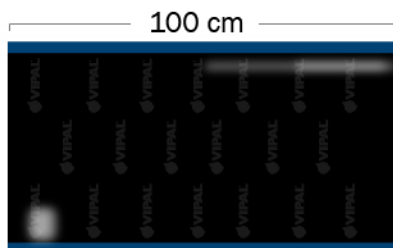

**Código: COJ005**

Cojin VIPAL MB/AC por metro.  
23.5 x 100 cm.

REF.: 1u/pack

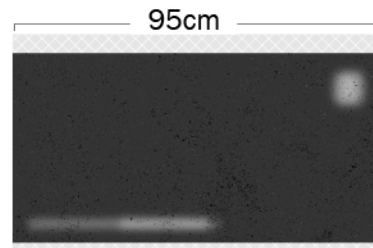

**Código: COJ004**

Lona para vulcanizar.  
95x48 cm.

REF.: 1u/pack



**Código: PAS001**

Pasta de montaje VIPAL.  
balde de 3,6kg / 7.93lb.

REF.: 1u/pack



**Código: TIZ004**

Crayon amarillo VIPAL.  
10x100mm.

REF.: 12u/pack



**Código: MEC001**

Mecha negra.  
4" corta.

REF.: 60u/pack



**Código: MEC003**

Mecha corta.  
4" delgada.

REF.: 120u/pack



**Código: MEC005**

Mecha corta.  
4" gruesa.

REF.: 60u/pack



**Código: MEC006**

Mecha larga.  
8" gruesa.

REF.: 25u/pack



**Código: LEZ001**

Kit de lezna introductora 4 en 1.  
(no incluye mechas)

REF.: 1u/pack



**Código: LEZ002**

Lezna helicoidal desarmable  
(no incluye mechas)

REF.: 1u/pack



**Código: LEZ007**

Lezna introductora desarmable.  
(no incliye mechas)

REF.: 1u/pack



**KIT DE LEZNAS METE MECHAS**

**Código: LEZ009**

Kit mete mechas completo. Incluye dos leznas (helicoidal e introductora) pega para mechas, cuatro paquetes de mechas (5 mechas en cada uno) estilete, dos llaves hexagonales y estuche.

REF.: 27pcs/pack



**Código: LEZ003**

Kit de leznas mango plástico mas 5 mechas y pega.

REF.: 1u/pack



**Código: LEZ010**

Kit de leznas mango metálico mas 5 mechas y pega.

REF.: 1u/pack



**Código: LEZ012**

Lezna limadora mango metálico.

REF.: 1u/pack



**Código: LEZ008**

Punzón helicoidal mango de plástico.

REF.: 1u/pack



**Código: LEZ011**

Punzón para revisión de llanta mango de plástico.

REF.: 1u/pack



**KIT TURBINA AIR TOOL**

**Código: HEN001**

Kit de turbina air tool 22.000 Rpm. Incluye 10 piedras para pulir (5 pcs 1/4" y 5 pcs 1/8"), 1 adaptador de piedra, 1 conector de aire 2 llaves para ensamblar y estuche.

REF.: 15pcs/pack



**Código: HEN040**

Turbina de aire Chicago Pneumatic CP873. 2.800Rpm.

REF.: 1u/pack



**Código: HEN012**

Tubina de aire con amoladora. 22.000Rpm.

REF.: 1u/pack



**Código: PIE005**

Adaptador de piedra de 1/4".

REF.: 1u/pack





**Código: PIE001**

Kit de piedras para pulir moler y desbastar.

REF.: 3u/pack



**Código: PIE003**

Piedra tipo disco de tungsteno.

REF.: 1u/pack



**Código: PIE002**

Piedra ventilada de tungsteno. pequeña.

REF.: 1u/pack



**Código: PIE004**

Piedra tipo bola de tungsteno.

REF.: 1u/pack



**Código: PIE013**

Piedra ventilada de tungsteno grande.

REF.: 1u/pack



**Código: PIE014**

Piedra tipo bola 40mm diametro

REF.: 1u/pack



**Código: ROD001**

Rodillo pequeño de 4mm.

REF.: 1u/pack



**Código: ROD002**

Rodillo de 6mm.

REF.: 1u/pack



**Código: ROD003**

Rodillo de 40mm.

REF.: 1u/pack



**Código: RAS001**

Raspador tipo espátula.

REF.: 1u/pack



**Código: BR0001**

Brocha para pasta de enllantar plastica recta.

REF.: 1u/pack



**Código: BR0002**

Brocha para pasta de enllantar plastica curva

REF.: 1u/pack



**Código: PAS004**

Pasta de montaje LUBRIVERMAR.  
balde de 5kg / 8.8lb

REF.: 1u/pack



**Código: PAS003**

Gel para enllantar BUFFALO.  
balde de 4kg / 8.8lb.

REF.: 1u/pack



**Código: PAS008**

Pasta de montaje TIP-TOP.  
balde de 5kg.

REF.: 1u/pack



**Código: PAS002**

Pasta de montaje BUFFALO.  
balde de 3kg /6.61lb.

REF.: 1u/pack



**BASE SEPARADOR DE LLANTAS**

**Código: HEN036**

Base separadora de llantas para parchar con  
eje ajustable y soporte para herramientas.

REF.: 1U/pack



**Código: HEN048**

Vulcanizadora de mesa.  
Voltaje: 110v. Consumo: 500w.  
Temperatura: 145 - 165. Area de reparo: 60x60mm.

REF.: 1u/pack

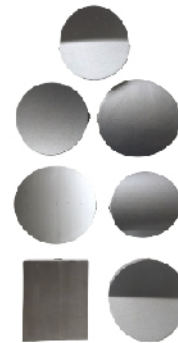

**Código: HEN007**

Vulcanizadora tipo prensa y platos para vulcanizar.  
Voltaje: 110v. Consumo: 1000w.  
Temperatura: 145 - 165. Area de reparo: 650x335x100mm.

REF.: 1u/pack

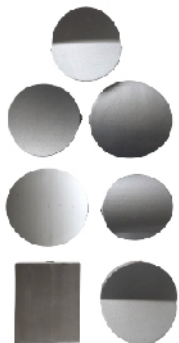

**Código: HEN006**

Vulcanizadora con pedestal mas platos para vulcanizar.  
Voltaje: 220v. Consumo: 1000w.  
Temperatura: 145 - 160. Area de reparo: 650x335x100mm.

REF.: 1u/pack



**Código: TER002**

Plancha para vulcanizadora.

REF.: 1u/pack



**Código: TER001**

Termostato para vulcanizadora.

REF.: 1u/pack

# PEGAS **REMA TIP TOP**

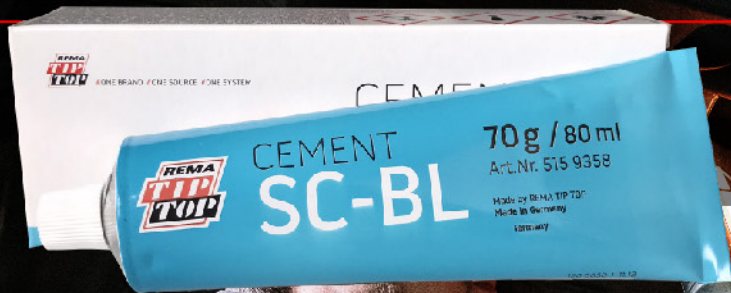

**Código: PEG007**

Pega Rema TIP TOP cemnet SC-BL  
70g / 80ml.

REF.: 1U/pack

**Código: PEG027**

Pega Rema TIP TOP cemnet SC-BL  
200g / 230ml.

REF.: 1U/pack



CEMENT  
**SC-BL**

200 g / 230 ml  
Art.Nr. 515 9366

Made by REMA TIP TOP  
Made in Germany



**Código: PEG006**

Pega Rema TIP TOP cemnet SC-BL  
650g/740ml.

REF.: 1U/pack

CEMENT  
**SC-BL**

650 g / 740ml  
Art.Nr. 515 9389

Made by REMA TIP TOP  
Made in Germany

**NUEVO**

**MILTON**



# 580e

**MEDIDOR DE AIRE**

**PRECISIÓN EXTREMA  $\pm 0.05\%$**

**EMPUÑADURA ERGONÓMICA**

**PANTALLA DIGITAL CON ROTOSCOPIO**

**PAGINA 51**



# ALINEACIÓN Y BALANCEO



www.lavalvula.com.ec

@lavalvula





**PESAS DE BALANCEO BUFFALO DE PLOMO CON VINCHA REGULAR**



**Pb**

<b>RA 1/4 - 0.25oz - 7g</b>		<b>Código: PRA001</b> REF.: 100u/pack
<b>RA 1/2 - 0.50oz - 14g</b>		<b>Código: PRA002</b> REF.: 100u/pack
<b>RA 3/4 - 0.75oz - 21g</b>		<b>Código: PRA003</b> REF.: 100u/pack
<b>RA 1 - 1.00oz - 28g</b>		<b>Código: PRA004</b> REF.: 100u/pack
<b>RA 1 1/4 - 1.25oz - 35g</b>		<b>Código: PRA005</b> REF.: 50u/pack
<b>RA 1 1/2 - 1.50oz - 42g</b>		<b>Código: PRA006</b> REF.: 50u/pack
<b>RA 1 3/4 - 1.75oz - 50g</b>		<b>Código: PRA007</b> REF.: 50u/pack
<b>RA 2 - 2.00oz - 57g</b>		<b>Código: PRA008</b> REF.: 50u/pack
<b>RA 2 1/4 - 2.25oz - 64g</b>		<b>Código: PRA009</b> REF.: 50u/pack
<b>RA 2 1/2 - 2.50oz / 71g</b>		<b>Código: PRA010</b> REF.: 50u/pack
<b>RA 2 3/4 - 2.75oz - 78g</b>		<b>Código: PRA011</b> REF.: 50u/pack
<b>RA 3 - 3.00oz / 85g</b>		<b>Código: PRA012</b> REF.: 50u/pack
<b>RA 4 - 4.00oz / 113g</b>		<b>Código: PRA013</b> REF.: 25u/pack
<b>RA 5 - 5.00oz / 141g</b>		<b>Código: PRA014</b> REF.: 25u/pack
<b>RA 6 - 6.00oz / 170g</b>		<b>Código: PRA015</b> REF.: 25u/pack

**Pb**



**PESAS DE BALANCEO BUFFALO DE PLOMO CON VINCHA MC**



<b>MC 1/4 - 0.25oz - 7g</b>		<b>Código: PMC001</b> REF.: 100u/pack
<b>MC 1/2 - 0.50oz - 14g</b>		<b>Código: PMC002</b> REF.: 100u/pack
<b>MC 3/4 - 0.75oz - 21g</b>		<b>Código: PMC003</b> REF.: 100u/pack
<b>MC 1 - 1.00oz - 28g</b>		<b>Código: PMC004</b> REF.: 100u/pack
<b>MC 1 1/4 - 1.25oz - 35g</b>		<b>Código: PMC005</b> REF.: 50u/pack
<b>MC 1 1/2 - 1.50oz - 42g</b>		<b>Código: PMC006</b> REF.: 50u/pack
<b>MC 1 3/4 - 1.75oz - 50g</b>		<b>Código: PMC007</b> REF.: 50u/pack
<b>MC 2 - 2.00oz - 57g</b>		<b>Código: PMC008</b> REF.: 50u/pack
<b>MC 2 1/4 - 2.25oz - 64g</b>		<b>Código: PMC009</b> REF.: 50u/pack
<b>MC 2 1/2 - 2.50oz - 71g</b>		<b>Código: PMC010</b> REF.: 50u/pack
<b>MC 2 3/4 - 2.75oz - 78g</b>		<b>Código: PMC011</b> REF.: 50u/pack
<b>MC 3 - 3.00oz - 85g</b>		<b>Código: PMC012</b> REF.: 50u/pack











**PESAS DE BALANCEO DE HIERRO CON VINCHA REGULAR**



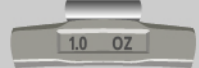
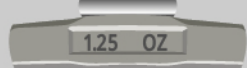
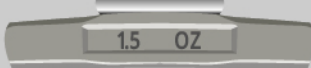

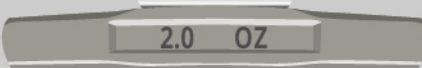

**Fe**

<b>Fe P 1/4 - 0.25oz - 7g</b>		<b>Código: PHE001</b> REF.: 100u/pack
<b>Fe P 1/2 - 0.50oz - 14g</b>		<b>Código: PHE002</b> REF.: 100u/pack
<b>Fe P 3/4 - 0.75oz - 21g</b>		<b>Código: PHE003</b> REF.: 100u/pack
<b>Fe P 1 - 1.00oz - 28g</b>		<b>Código: PHE004</b> REF.: 100u/pack
<b>Fe P 1 1/4 - 1.25oz - 35g</b>		<b>Código: PHE005</b> REF.: 50u/pack
<b>Fe P 1 1/2 - 1.50oz - 42g</b>		<b>Código: PHE006</b> REF.: 50u/pack
<b>Fe P 1 3/4 - 1.75oz - 50g</b>		<b>Código: PHE007</b> REF.: 50u/pack
<b>Fe P 2 - 2.00oz - 57g</b>		<b>Código: PHE008</b> REF.: 50u/pack



**PESAS DE BALANCEO DE HIERRO CON VINCHA MC**

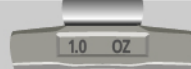
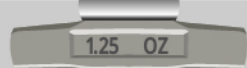
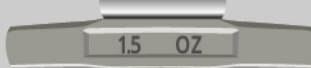
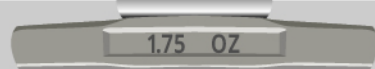







<b>Fe MC 1/4 - 0.25oz - 7g</b>		<b>Código: PHD001</b> REF.: 100u/pack
<b>Fe MC 1/2 - 0.50oz - 14g</b>		<b>Código: PHD002</b> REF.: 100u/pack
<b>Fe MC 3/4 - 0.75oz - 21g</b>		<b>Código: PHD003</b> REF.: 100u/pack
<b>Fe MC 1 - 1.00oz - 28g</b>		<b>Código: PHD004</b> REF.: 100u/pack
<b>Fe MC 1 1/4 - 1.25oz - 35g</b>		<b>Código: PHD005</b> REF.: 50u/pack
<b>Fe MC 1 1/2 - 1.50oz - 42g</b>		<b>Código: PHD006</b> REF.: 50u/pack
<b>Fe MC 1 3/4 - 1.75oz - 50g</b>		<b>Código: PHD007</b> REF.: 50u/pack
<b>Fe MC 2 - 2.00oz - 57g</b>		<b>Código: PHD008</b> REF.: 50u/pack

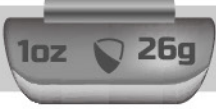

**Pb**



**PESAS DE BALANCE BUFFALO DE PLOMO PARA CAMIÓN LIVIANO**

<b>1oz / 26g</b>		<b>Código: PPC001</b> REF.: 50u/pack
<b>2oz / 57g</b>		<b>Código: PPC002</b> REF.: 50u/pack
<b>3oz / 85g</b>		<b>Código: PPC003</b> REF.: 50u/pack
<b>4oz / 113g</b>		<b>Código: PPC004</b> REF.: 25u/pack
<b>5oz / 141g</b>		<b>Código: PPC005</b> REF.: 25u/pack
<b>6oz / 170g</b>		<b>Código: PPC006</b> REF.: 20u/pack



**PESAS DE BALANCE  
PARA CAMIÓN LIVIANO**



**PESAS DE BALANCEO BUFFALO DE PLOMO CON VINCHA ET**

**Pb**

PESAS DE BALANCEO CON VINCHA

**ET 2oz / 57g**



**Código: PET002**

REF.: 50u/pack

**ET 3oz / 85g**



**Código: PET003**

REF.: 50u/pack

**ET 4oz / 113g**



**Código: PET004**

REF.: 25u/pack

**ET 5oz / 141g**



**Código: PET005**

REF.: 25u/pack

**ET 6oz / 170g**



**Código: PET006**

REF.: 25u/pack

**ET 7oz / 196g**



**Código: PET007**

REF.: 20u/pack

**ET 8oz / 226g**



**Código: PET008**

REF.: 20u/pack

**ET 9oz / 255g**



**Código: PET009**

REF.: 20u/pack

**ET 10oz / 283g**



**Código: PET010**

REF.: 15u/pack

**ET 12oz / 351g**



**Código: PET012**

REF.: 15u/pack



**Pb**



**PESAS DE BALANCEO BUFFALO DE PLOMO CON VINCHA I7**

<b>172oz / 57g</b>		<b>Código: PI7002</b> REF.: 50u/pack
<b>17 3oz / 85g</b>		<b>Código: PI7003</b> REF.: 50u/pack
<b>17 4oz / 113g</b>		<b>Código: PI7004</b> REF.: 25u/pack
<b>17 5oz / 141g</b>		<b>Código: PI7005</b> REF.: 25u/pack
<b>17 6oz / 170g</b>		<b>Código: PI7006</b> REF.: 25u/pack
<b>17 7oz / 196g</b>		<b>Código: PI7007</b> REF.: 20u/pack
<b>17 8oz / 226g</b>		<b>Código: PI7008</b> REF.: 20u/pack
<b>17 10oz / 283g</b>		<b>Código: PI7010</b> REF.: 15u/pack
<b>17 12oz / 351g</b>		<b>Código: PI7012</b> REF.: 15u/pack





**Código: PAD013**

Pesa adhesiva de hierro de lujo.  
7g / 0.25oz.

REF.: 50u/pack



**Código: PAD016**

Pesa adhesiva de hierro de lujo.  
14g / 0.50oz.

REF.: 50u/pack

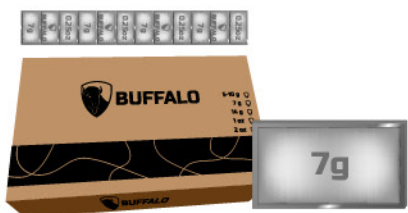

**Código: PAD112**

Pesa adhesiva de plomo BUFFALO.  
7g / 0.25oz.

REF.: 30u/pack



**Código: PAD113**

Pesa adhesiva de plomo BUFFALO.  
14g / 0.50oz.

REF.: 50u/pack



**Código: PAD114**

Pesa adhesiva de plomo BUFFALO  
para camión 1oz / 28g.

REF.: 20u/pack



**Código: PAD115**

Pesa adhesiva de plomo BUFFALO  
para camión 2oz / 57g.

REF.: 30u/pack



**Código: PAD111**

Pesa adhesiva de plomo BUFFALO  
para moto. 5g / 10g.

REF.: 50u/pack



**Código: PAD111**

Pesa adhesiva de plomo buffalo  
para moto. 5g / 10g.

REF.: 50u/pack



**Código: HRM014**

Martillo para pesas profesional TOPTUL.

REF.: 1u/pack



**Código: HRM005**

Martillo para pesas con gancho empaque rojo.

REF.: 1u/pack



**Código: HRM016**

Martillo KEN TOOL profesional para Pesas de balanceo.

REF.: 1u/pack



**Código: HRM010**

Martillo para pesas empaque rojo largo.

REF.: 1u/pack



**Código: HRM022**

Martillo empaque rojo con punta de goma.

REF.: 1u/pack



**Código: REM001**

Removedor de pesas adhesivas plastico.

REF.: 1u/pack

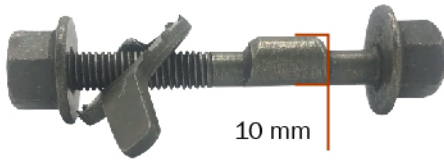

**Código: PEX001**

Perno excéntrico TS 10.9  
10mm

REF.: 20u/pack

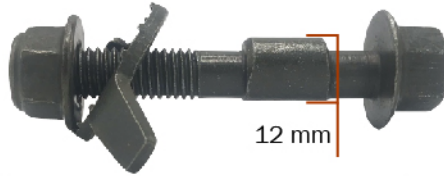

**Código: PEX002**

Perno excéntrico TS 12.9  
12mm

REF.: 20u/pack

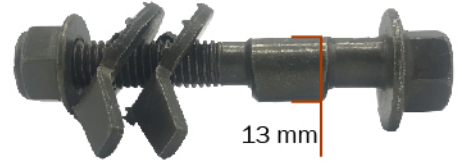

**Código: PEX003**

Perno excéntrico TS10.9  
13 mm

REF.: 10u/pack



**Código: PEX004**

Perno excéntrico TS 12.9.  
14mm

REF.: 12u/pack



**Código: PEX006**

Perno excéntrico TS 12.9.  
15mm

REF.: 10u/pack

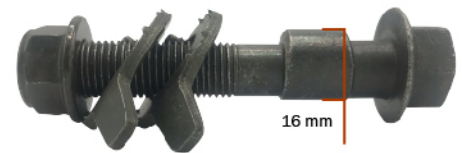

**Código: PEX007**

Perno excéntrico TS12.9.  
16 mm

REF.: 10u/pack



**Código: PEX008**

Perno excéntrico TS 12.9.  
17mm

REF.: 10u/pack



**Código: FRE001**

Fresa BURS 1/4 MD  
10x20mm

REF.: 1u/pack

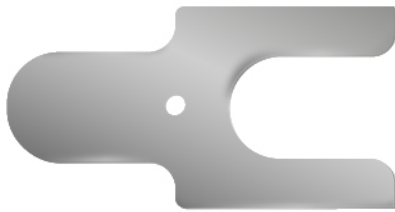

**Código: LDA001**

Laina de alineación delgada.  
1/36.

REF.: 100u/pack

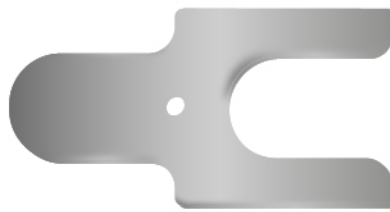

**Código: LDA002**

Laina de alineación mediana.  
1/16.

REF.: 100u/pack

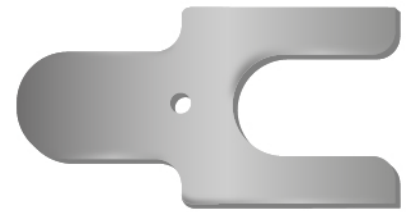

**Código: LDA003**

Laina de alineación gruesa.  
1/8.

REF.: 100u/pack



**Código: HEN025**

Nivel de camber 2 piezas.  
camber con base ajustable.

REF.: 2u/pack



**Código: HEN046**

Nivel de camber 1 pieza.

REF.: 1u/pack



**Código: HEN045**

Seguro de volantes para alinear  
bloquea el volante del auto.

REF.: 1u/pack



**Código: HEN027**

Seguro de volantes para alinear  
bloquea el volante del auto.

REF.: 1u/pack



**Código: MDA002**

Medidor de aros plasticos  
regla para medir aros

REF.: 1u/pack



**Código: HEN010**

Platos de alineación  
para llantas delanteras.

REF.: 2u/pack



**Código: CDP001**

Calibrador digital BP 6"

REF.: 1u/pack



**Código: REP007**

Cabeza de enllantadora 28mm

REF.: 1u/pack



**Código: REP008**

Cabeza de enllantadora 29mm

REF.: 1u/pack



**Código: REP009**

Cabeza de enllantadora 30mm

REF.: 1u/pack



**Código: REP004**

Mariposa para maquinas  
de balancear 36mm.

REF.: 1u/pack



**Código: REP005**

Mariposa para maquinas  
de balancear 38mm.

REF.: 1u/pack



**Código: REP006**

Mariposa para maquinas  
de balancear 40mm.

REF.: 1u/pack



**NUEVO**



**BUFFALO**

# KIT DADOS DE IMPACTO



CÓDIGO:  
**DAD010**

**INCLUYE:**  
**DADO 17, 21, 24, 27**  
**30, 32, 33, 34, 36 Y 41mm**

**PAGINA 52**

**NUEVO**

# Guantes de seguridad

**CÓDIGO: EPP001**

Guantes de seguridad  
Talla: M



**CÓDIGO: EPP002**

Guantes de seguridad  
Talla: L



**CÓDIGO: EPP003**

Guantes de seguridad  
Talla: S



# TUERCAS Y PERNOS



[www.lavalvula.com.ec](http://www.lavalvula.com.ec)

@lavalvulaec



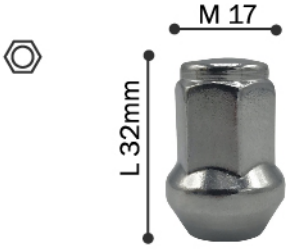

**Código: TNL011**

Tuerca normal mando 17.  
Medida: 10x1,25 L32mm

REF: 50u/pack

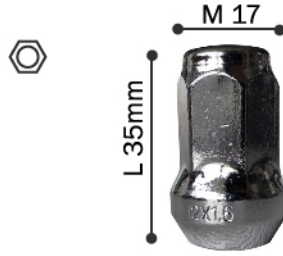

**Código: TNL017**

Tuerca normal mando 17.  
Medida: 12x1,50 L35mm.

REF: 50u/pack

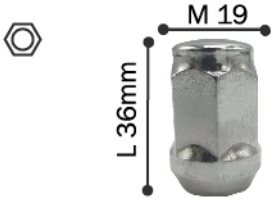

**Código: TNL002**

Tuerca normal mando 19.  
Medida: 12x1,25 L 36mm.

REF: 50u/pack

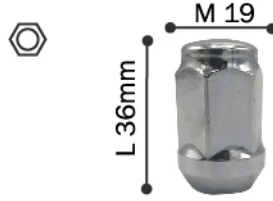

**Código: TNL005**

Tuerca normal mando 19.  
Medida: 12x1,50 L 36mm.

REF: 50u/pack

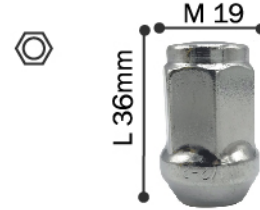

**Código: TNL020**

Tuerca normal mando 19.  
Medida: 1/2 x 20 L 36mm.

REF: 50u/pack

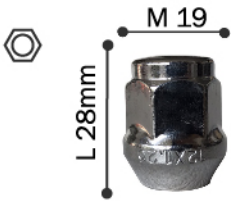

**Código: TNL035**

Tuerca normal mando 19.  
Medida: 12x1,25 L 28mm.

REF: 50u/pack

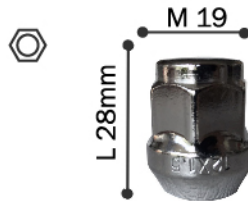

**Código: TNL036**

Tuerca normal mando 19.  
Medida: 12x1,50 L 28mm.

REF: 50u/pack

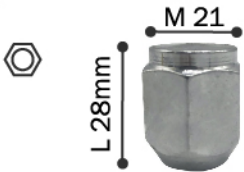

**Código: TNL003**

Tuerca normal mando 21.  
Medida: 12x1,25 L 28mm.

REF: 50u/pack

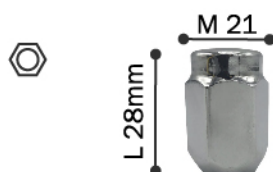

**Código: TNL006**

Tuerca normal mando 21.  
Medida: 12 x 1,50 L 36mm.

REF: 50u/pack



**Código: TNL030**

Tuerca de aluminio normal roja.  
Medida: 12x1,50.

REF: 20u/pack



**Código: TNL028**

Tuerca de aluminio normal azul  
Medida: 12x1,50.

REF: 20u/pack



**Código: TNL029**

Tuerca de aluminio normal  
amarillo. Medida: 12x1,50.

REF: 20u/pack

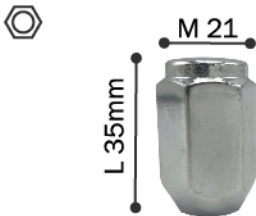
**Código: TNL004**

Tuerca normal mando 21.  
 Medida: 12x1,25 L 35mm.

REF.: 50u/pack

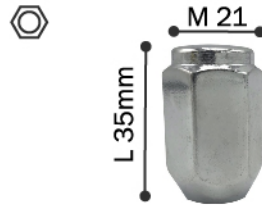
**Código: TNL010**

Tuerca normal mando 21.  
 Medida: 12x1,50 L 35mm.

REF.: 50u/pack

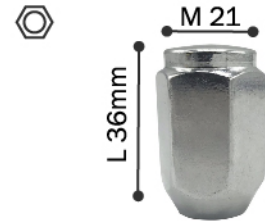
**Código: TNL018**

Tuerca normal mando 21.  
 Medida: 7/16 L 35mm.

REF.: 50u/pack

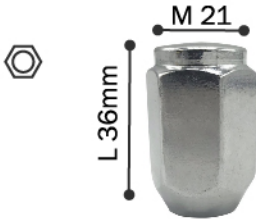
**Código: TNL019**

Tuerca normal mando 21.  
 Medida: 12x1,75 L 35mm.

REF.: 50u/pack

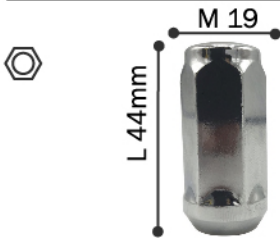
**Código: TNL021**

Tuerca normal mando 19.  
 Medida: 14x1,50 L 44mm.

REF.: 50u/pack

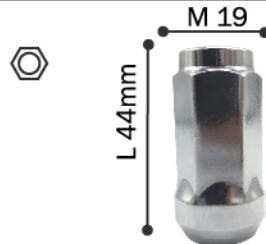
**Código: TNL012**

Tuerca normal mando 19.  
 Medida: 14x2 L 44mm.

REF.: 50u/pack

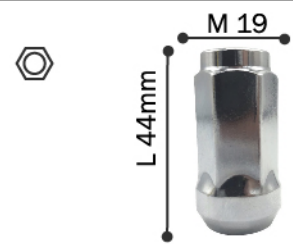
**Código: TNL027**

Tuerca normal mando 19.  
 Medida: 9/16 L 44mm.

REF.: 50u/pack

**Código: TNL031**

Tuerca normal Toyota mando 21.  
 Medida: 12x1,25 L 36mm.

REF.: 25u/pack

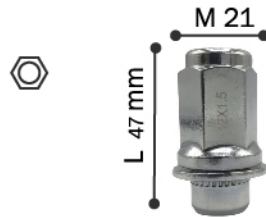
**Código: TNL025**

Tuerca normal TOYOTA mando 21.  
 Medida: 12x1,50 L 36mm.

REF.: 30u/pack

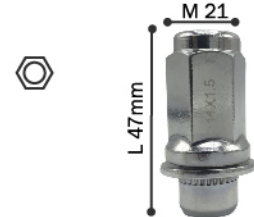
**Código: TNL034**

Tuerca normal Toyota mando 21.  
 Medida: 14x1,50 L 47mm.

REF.: 50u/pack

**Código: TNL037**

Tuerca normal Toyota mando 21.  
 Medida: 12x1,25 L 36mm.

REF.: 25u/pack



**Código: TEC001**

Tuerca especial cromada.  
Medida: 10x1,25.

REF.: 50u/pack



**Código: TEC002**

Tuerca especial cromada.  
Medida: 12x 1,25.

REF.: 50u/pack



**Código: TEC003**

Tuerca especial cromada.  
Medida: 12x1,50.

REF.: 50u/pack



**Código: TEC004**

Tuerca especial cromada.  
Medida: 14x1,50.

REF.: 50u/pack

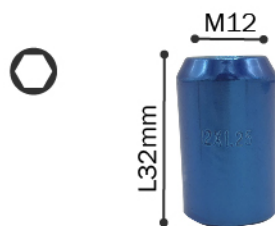

**Código: TEC005**

Tuerca especial cromada azul.  
Medida: 12x 1,25.

REF.: 50u/pack

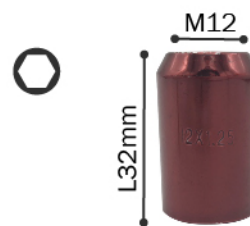

**Código: TEC007**

Tuerca especial cromada roja.  
Medida: 12x1,50.

REF.: 50u/pack



**Código: TSG001**

Kit tuerca de seguridad.  
Medida: 12x1,25.

REF.: 4u/pack + 1 llave



**Código: TSG002**

Kit tuerca de seguridad.  
Medida: 12x 1,50.

REF.: 4u/pack + 1 llave



**Código: TSG003**

Kit tuerca de seguridad.  
Medida: 14x1,50.

REF.: 4u/pack + 1 llave



**Código: TSG004**

Kit tuerca de seguridad.  
Medida: 10x1,25.

REF.: 4u/pack + 1 llave



**Código: TSG005**

Kit tuerca de seguridad.  
Medida: 14x2 L44mm.

REF.: 4u/pack + 1 llave



**Código: TSG006**

Kit tuerca de seguridad.  
Medida: 12x1,25.

REF.: 4u/pack + 2 llave

**Código: TSG008**

Kit tuerca de seguridad.  
 Medida: 12x1,50.

REF.: 4u/pack + 2 llave

**Código: TSG009**

Kit tuerca de seguridad.  
 Medida: 12x 1,25.

REF.: 4u/pack + 1 llave

**Código: TSG010**

Kit tuerca de seguridad.  
 Medida: 14x2.

REF.: 4u/pack + 1 llave

**Código: TSG011**

Kit tuerca de seguridad.  
 Medida: 12x1,50 L 44mm.

REF.: 4u/pack + 1 llave

**Código: TSG012**

Kit tuerca de seguridad.  
 Medida: 12x1,25 L 44mm.

REF.: 4u/pack + 1 llave

**Código: TSG013**

Kit tuerca de seguridad.  
 Medida: 1/2 - 20.

REF.: 4u/pack + 1 llave

**Código: PNL001**

Perno normal mando 17.  
 Medida: 12x1,25.

REF.: 50u/pack

**Código: PNL003**

Perno normal mando 17.  
 Medida: 12x 1,50.

REF.: 50u/pack

**Código: PNL004**

Perno normal mando 17.  
 Medida: 14x1,50.

REF.: 50u/pack

**Código: PEC001**

Perno especial cromado.  
 Medida: 12x1,25.

REF.: 50u/pack

**Código: PEC002**

Perno especial cromado.  
 Medida: 12x1,50.

REF.: 50u/pack

**Código: PEC003**

Perno especial cromado.  
 Medida: 14x1,50.

REF.: 50u/pack



**Código: PEC004**

Perno especial cromado  
Medida: 14X1,50.

REF.: 50u/pack



**Código: PSG001**

Kit perno de seguridad.  
Medida: 12x1,25.

REF.: 4u/pack + 1 llave



**Código: PSG002**

Kit perno de seguridad.  
Medida: 12x1,50.

REF.: 4u/pack + 1 llave



**Código: PSG003**

Kit perno de seguridad.  
Medida: 14x1,50.

REF.: 4u/pack + 1 llave



**Código: PSG004**

Kit perno de seguridad.  
Medida: 12x 1,25

REF.: 4u/pack + 1 llave



**Código: LLH001**

Llave hexagonal negra.

REF.: 1u/pack



**Código: LLH002**

Llave hexagonal plateada.

REF.: 1u/pack



**Código: LLH003**

Llave hexagonal cromada.

REF.: 1u/pack



**Código: LLH006**

Llave hexagonal reforzada.

REF.: 1u/pack



**Código: LLH004**

Adaptador para tuerca.

REF.: 1u/pack

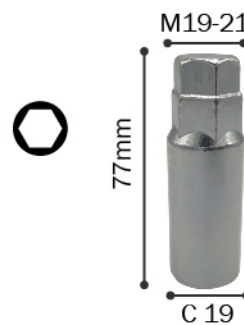

**Código: LLH005**

Adaptador para tuerca.  
Copa 19 / M 19 - 21

REF.: 1u/pack



**Código: LLH008**

Adaptador de tuerca.  
L64 copa 21 / M 19-21.

REF: 1u/pack

**Código: LLH007**

Llave hexagonal de impacto.  
GR-MO H12.

REF: 1u/pack

**Código: ESP002**

Separador 3mm.  
Huecos 4-5 / 98 - 120mm.

REF.: 4u/pack

**Código: ESP004**

Separador 6mm.  
Huecos 5-6 / 130 - 139,7mm.

REF.: 4u/pack

**Código: ESP005**

Separador 5mm.  
Huecos 4-5 / 98-120mm.

REF.: 4u/pack

**Código: ESP006**

Separador 6mm.  
Huecos 4-5 / 98-120mm.

REF.: 4u/pack

**Código: ESP008**

Separador 8mm.  
Huecos 4-5 / 98-120mm.

REF.: 4u/pack



**Código: ESP001**

Separador 317 mm.  
Huecos 6 / 139,7-139,7mm

REF: 2u/pack



**Código: ESP003**

Separador 317 mm.  
Huecos 6 / 127-139,7mm

REF: 2u/pack



**Código: CEN001**

Centrador plastico.  
Medida: de 73.1 a 56.6.

REF.: 1u/pack



**Código: CEN002**

Centrador plastico.  
Medida: de 73.1 a 67.1.

REF.: 1u/pack



**Código: CEN003**

Centrador plastico.  
Medida: de 67.1 a 56.6.

REF.: 1u/pack

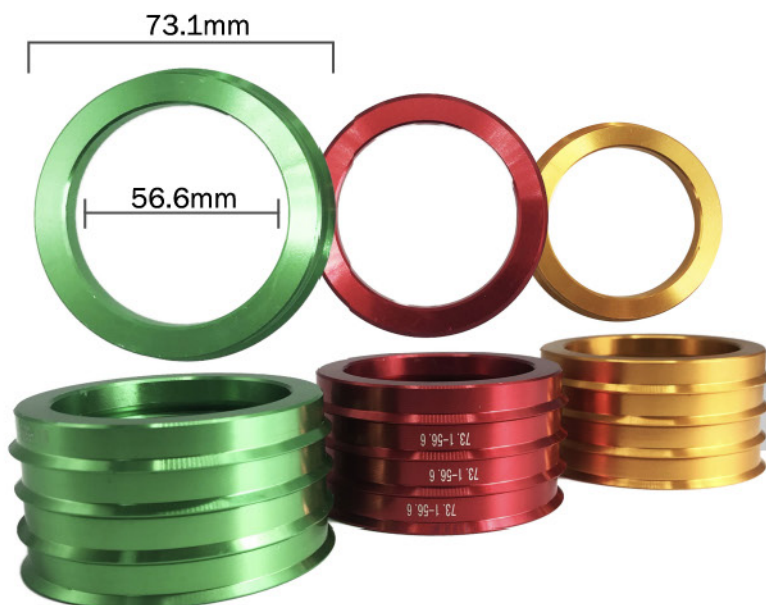

**Código: CEN004**

Centrador aluminio de colores.  
Medida: de 73.1 a 66.6.

REF.: 1u/pack



**Código: MDA001**

Medidor de distancia de huecos.

REF: 1u/pack.

**NUEVO**

# **S-568**

**MEDIDOR DE AIRE**

**PRECISIÓN EXTREMA  $\pm 0.05\%$**

**EMPUÑADURA ERGONÓMICA**

**MANOMETRO DIGITAL**





**BUFFALO**

**HEN045**



**SOPORTE DE VOLANTE**

**HERRAMIENTA PARA FIJAR  
VOLANTES DURANTE LA  
ALINEACIÓN**



**Chicago  
Pneumatic**

**DAD026**

**DADOS DE  
IMPACTO**



**MILTON**





**Conección Hembra**

**Conección Macho**



**Código: ACP001**

Acople rápido 715.  
Conección: 1/4" FNPT.

REF.: 1u/pack



**Código: ACP002**

Acople rápido 716.  
Conección: 1/4" FNPT.

REF.: 1u/pack



**Código: CNT001**

Conector Milton 727.  
Conección: 1/4" MNTP.

REF.: 1u/pack



**Código: ACP010**

Acople rápido S-99705.  
Conección: 1/4" FNPT.

REF.: 1u/pack



**Código: ACP016**

Acople rápido 1750.  
Conección: 1/4" FNPT.

REF.: 1u/pack



**Código: CNT002**

Conector Milton 728.  
Conección: 1/4" MNTP.

REF.: 1u/pack



**Código: ACP017**

Acople rápido 1803.  
Conección: 1/4" - 3/8" FNPT.

REF.: 1u/pack



**Código: ACP015**

Acople rápido 1804.  
Medida: 1/4" - 3/8" MNTP

REF.: 1u/pack



**Código: CNT009**

Conector Milton 1809.  
Medida: 1/4" - 3/8" MNTP.

REF.: 1u/pack

 **Conección Hembra**

 **Conección Macho**

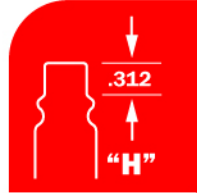

**Código: ACP008**

Acople rápido 1835.  
Conección: 3/8" - 3/8" FNPT.  
REF.: 1u/pack



**Código: CNT004**

Conector Milton 1837.  
Medida: 3/8" - 3/8" MNPT.  
REF.: 1u/pack



**Código: ACP005**

Acople rápido 1815.  
Medida: 1/2" - 1/2" FNPT.  
REF.: 1u/pack



**Código: ACP006**

Conector Milton 1817.  
Medida: 1/2" - 1/2" MNPT.  
REF.: 1u/pack

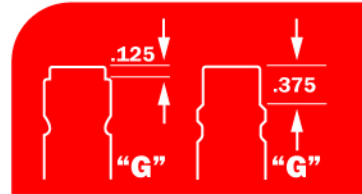

ESTILO "H" FLUJO DE AIRE 3/8"

ESTILO "G" FLUJO DE AIRE 1/2"

REDUCTORES



**Código: RED001**

Reductor Milton 650.  
Medida: 1/4" a 1/8".  
REF.: 1u/pack



**Código: RED003**

Reductor Milton 651.  
Medida: 3/8" a 1/4".  
REF.: 1u/pack



**Código: RED004**

Reductor Milton 651-1.  
Medida: 1/2" a 1/4".  
REF.: 1u/pack



**Código: RED005**

Reductor Milton 652.  
Medida: 1/2" a 3/8".  
REF.: 1u/pack



**Código: RED006**

Reductor Milton 652-1.  
Medida: 3/4" a 1/4".  
REF.: 1u/pack



**Código: RED007**

Reductor Milton 652-4.  
Medida: 3/4" a 3/8".  
REF.: 1u/pack



**Código: RED008**

Reductor Milton 652-8.  
Medida: 3/4" a 1/2".  
REF.: 1u/pack



**Código: CNT011**

Conector 601.  
Medida: 5/16" - 1/4".  
REF.: 1u/pack

**Código: INF002**

Inflador Milton S-690  
cabeza curva.

REF.: 1u/pack

**Código: INF003**

Inflador milton 693  
Cbeza recta.

REF.: 1u/pack

**Código: INF008**

Repuesto cabeza curva 500-4  
para inflador o medidor.

REF.: 1u/pack

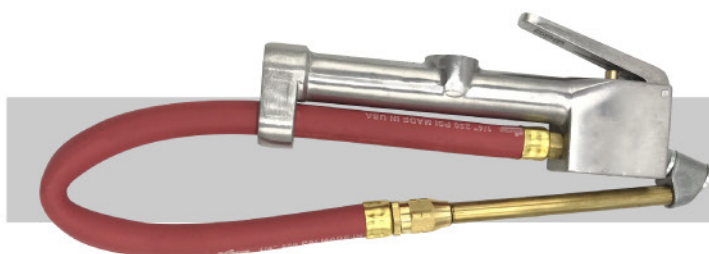
**Código: INF001**

Inflador Milton con manometro .  
Modelo S-506.  
Rango de presión : 0-106Psi.

REF.: 1u/pack

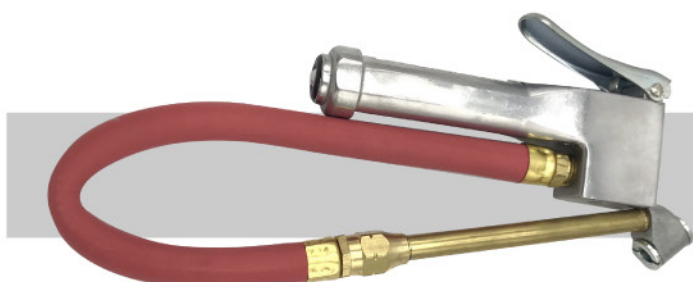
**Código: INF0011**

Inflador Milton estilo bayoneta.  
Modelo S-520.  
Rango de presión : 0-122Psi.

REF.: 1u/pack

**Código: INF015**

Inflador Milton manometro digital.  
Modelo S-568.  
Rango de presión : 0-255Psi.

REF.: 1u/pack

**Código: INF014**

Inflador Milton digital.  
Modelo 580e.  
Rango de presión : 0-1100Psi.

REF.: 1u/pack





**Código: MED002**

Medidor de aire Milton S-976  
cabeza curva dual.  
10-160 Psi / 80-1100Kpa.  
REF.: 1u/pack

**Código: MED003**

Medidor de aire Milton S-986  
cabeza recta dual.  
10-160 Psi / 80-1100Kpa.  
REF.: 1u/pack



**Código: MED001**

Medidor de aire Milton S-927  
cabeza curva dual.  
20-120 Psi / 120-820Kpa.  
REF.: 1u/pack



**Código: MED011**

Medidor de aire Milton S-928  
5-50 Psi / 40-350Kpa.  
REF.: 1u/pack



**Código: MED012**

Medidor de aire Milton S-976C  
cabeza curva dual.  
10-160 Psi / 80-1100Kpa.  
REF.: 1u/pack



**Código: MED013**

Medidor de aire Milton S-982  
cabeza recta dual.  
10-160 Psi / 80-1100Kpa.  
REF.: 1u/pack



**Código: PUL001**

Pulverizador Milton S-156  
14" Npt. - 14.0 Scfm.  
REF.: 1u/pack



**Código: EMP002**

Empaque acople rapido.  
REF.: 50u/pack



**Código: EMP005**

Empaque inflador y medidor.  
REF.: 50u/pack



**Conección Macho**



**Conección Push-on**



**Conección con Lengüeta**

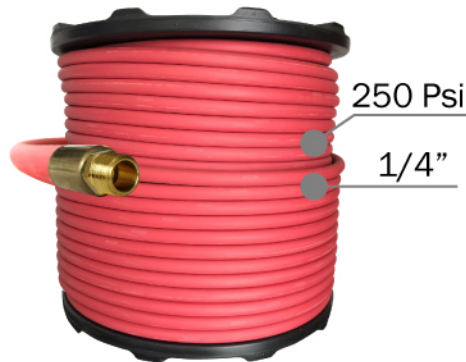

**Código: MAN014**

Manguera Milton 250Psi  
Medida: 1/4" x metros.

REF.: 1u/pack



**Código: CNT030**

Abrazadera 1654-5.  
Medida: 5/8"

REF.: 1u/pack



**Código: CNT010**

Conector Milton 600.  
Medida: 1/4" - 1/4".

REF.: 1u/pack



**Código: ACP001**

Acople rápido 715.  
Conección: 1/4" FNPT.

REF.: 1u/pack



**Código: ACP016**

Acople rápido 1750.  
Conección: 1/4" FNPT.

REF.: 1u/pack



**Código: CNT002**

Conector Milton 728.  
Conección: 1/4" MNTP.

REF.: 1u/pack



**Código: CNT006**

Conector Milton 736.  
Medida: 1/4"-1/4".

REF.: 1u/pack



**Código: ACP014**

Acople rápido 1717-4 estilo "M".  
Medida: 1/4" - 1/4"

REF.: 1u/pack



**Código: ACP011**

Acople rápido 717 estilo "M".  
Medida: 1/4" - 1/4"

REF.: 1u/pack



**Conección Macho**



**Conección Push-on**



**Conección con Lengüeta**

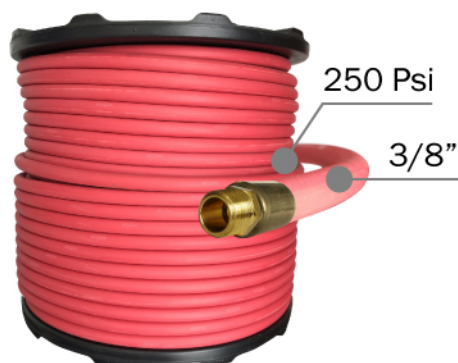

**Código: MAN015**

Manguera Milton 250Psi  
Medida: 3/8" x metros.

REF.: 1u/pack



**Código: CNT031**

Abrazadera 1654-8.  
Medida: 23/32"

REF.: 1u/pack



**Código: CNT012**

Conector 602.  
Medida: 1/4" 3/8".

REF.: 1u/pack



**Código: ACP017**

Acople rápido 1803.  
Conección: 1/4" - 3/8" FNPT.

REF.: 1u/pack



**Código: CNT008**

Conector milton 1736-6.  
Medida: 3/8" - 1/4".

REF.: 1u/pack



**Código: CNT007**

Conector Milton 736-6.  
Medida: 3/8"-3/8".

REF.: 1u/pack



**Código: ACP013**

Acople rápido 1717-6.  
Medida: 3/8" -1/4".

REF.: 1u/pack



**Código: ACP012**

Acople rápido 717-6.  
Medida: 3/8" - 1/4"

REF.: 1u/pack



**Código: ACP001**

Acople rápido 715.  
Conección: 1/4" - 1/4" FNPT.

REF.: 1u/pack



**Conección Macho**



**Conección Push-on**



**Conección Hembra**

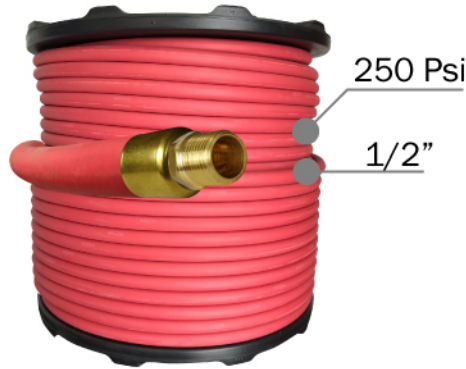

**Código: MAN016**

Manguera Milton 250Psi  
Medida: 1/2" x metros.

REF.: 1u/pack



**Código: CNT032**

Abrazadera 1654-12.  
Medida: 7/8".

REF.: 1u/pack



**Código: CNT005**

Conector Milton 604-1.  
Medida: 1/2" - 1/2" .

REF.: 1u/pack



**Código: CNT013**

Conector 604.  
Medida: 1/2" - 3/8".

REF.: 1u/pack



**Código: ACP005**

Acople rápido 1815.  
Medida: 1/2" - 1/2" FNPT.

REF.: 1u/pack



**Código: ACP006**

Conector Milton 1817.  
Medida: 1/2" - 1/2" MNPT.

REF.: 1u/pack

**NUEVO**



**HEN041**



**Chicago  
Pneumatic**

**PISTOLAS DE IMPACTO**



**HEN042**

**PAGINA 45**



# BUFFALO

## ACEITE PARA HERRAMIENTAS NEUMÁTICAS

**OIL009**



**OIL011**



**OIL010**



**OIL012**



**OIL013**



# PISTOLAS Y DADOS DE IMPACTO



[www.lavalvula.com.ec](http://www.lavalvula.com.ec)

@lavalvulaec







### Código: HEN042

Pistola de impacto CHICAGO PNEUMATIC CP7782-6.  
Cuadro de 1" / 5200Rpm / Torque 500-2000Nm.

REF.: 1u/pack

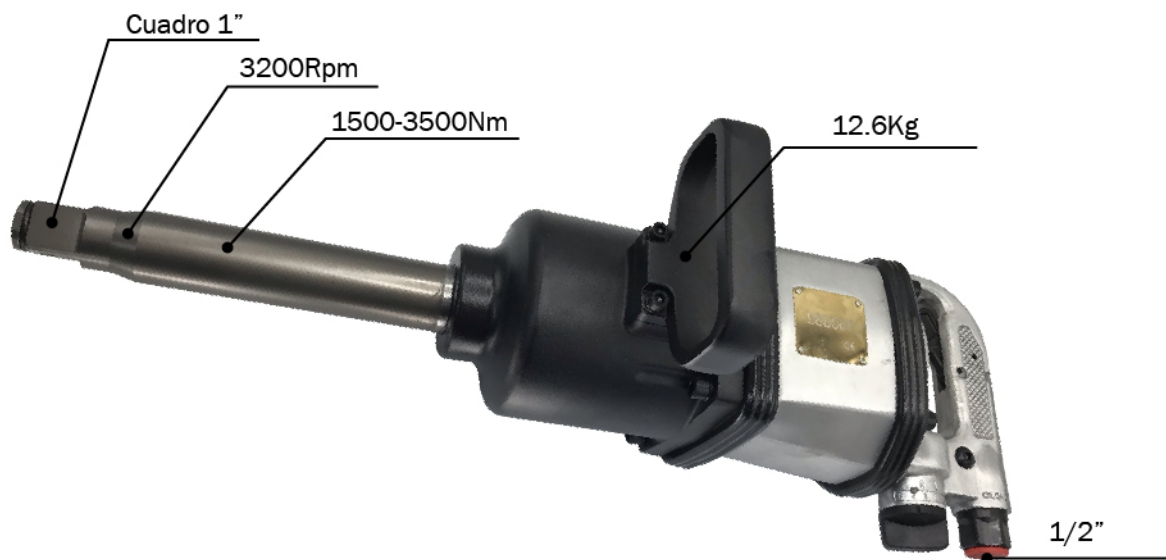

### Código: HEN047

Pistola de impacto BUFFALO.  
Cuadro de 1" / 3200Rpm / 1500-3500Nm.

REF.: 1u/pack



**Código: HEN022**

Pistola de impacto MARSHALL.  
Cuadro de 1" / 3200Rpm / Torque 1500-3000Nm.  
REF.: 1u/pack



**Código: HEN041**

Pistola de impacto Chicago Pneumatic CP7736-2.  
Cuadro de 1/2" / 10020Rpm / 69-770Nm.  
REF.: 1u/pack



**Código: HEN005**

Pistola de impacto 12B01B2.  
Cuadro de 1/2" / 8000Rpm / 200-700Nm.  
REF.: 1u/pack



**Código: HEN002**

Pistola de impacto 12A01P-B.  
Cuadro de 1/2" / 8000Rpm / 200-600Nm.  
REF.: 1u/pack



**Código: HEN003**

Pistola de impacto 12A01B2-B.  
Cuadro de 1/2" / 8000Rpm / 200-600Nm.  
REF.: 1u/pack



**Código: HEN009**

Pistola de impacto 12B01B6.  
Cuadro de 1/2" / 10020Rpm / 200-600Nm.

REF.: 1u/pack



**Código: HEN014**

Pistola de impacto 34B01B6.  
Cuadro de 3/4" / 6000Rpm / 650 - 1200Nm.

REF.: 1u/pack



**Código: OIL010**

Aceite para herramientas  
neumáticas 1001-32. 946ml.

REF.: 1u/pack



**Código: OIL011**

Aceite para herramientas  
neumáticas 1001-16. 473ml.

REF.: 1u/pack



**Código: OIL012**

Aceite para herramientas  
neumáticas 1001-4. 118ml.

REF.: 1u/pack



**Código: OIL009**

Aceite para compresor 1002-32.  
946ml.

REF.: 1u/pack



**Código: OIL013**

Limpiador para herramientas  
neumáticas 1003-4. 118ml

REF.: 1u/pack



**Código: DAD004**

Dado de impacto delgado.  
Medida: 1/2x17mm.

REF.: 1u/pack



**Código: DAD005**

Dado de impacto delgado.  
Medida: 1/2x19mm.

REF.: 1u/pack



**Código: DAD006**

Dado de impacto delgado.  
Medida: 1/2x21mm.

REF.: 1u/pack



**Código: DAD007**

Dado de impacto delgado corto.  
Medida: 1/2x22mm.

REF.: 1u/pack



**Código: DAD012**

Dado de impacto delgado corto.  
Medida: 1/2x21mm.

REF.: 1u/pack

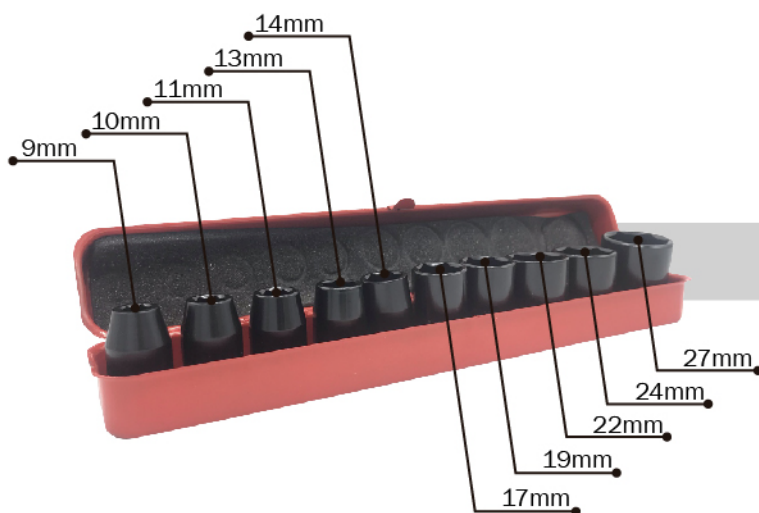

**Código: DAD003**

Set 10 dados de impacto con  
estuche metálico.

REF.: 10Pcs/pack



**Código: DAD0041**

Dado cromado largo TopTul.  
Medida: 1/2x17mm.

REF.: 1u/pack



**Código: DAD0051**

Dado cromado delgado TopTul.  
Medida: 1/2x19mm.

REF.: 1u/pack



**Código: DAD0062**

Dado cromado delgado TopTul.  
Medida: 1/2x21mm.

REF.: 1u/pack



**Código: DAD0031**

Set 3 dados de impacto 1/2 con estuche plastico.

REF.: 3Pcs/pack



**Código: DAD0032**

Set 3 dados de impacto 1/2 con estuche plastico.

REF.: 3Pcs/pack



**Código: DAD0052**

Dado de impacto delgado TopTul.  
Medida: 1/2x19mm.

REF.: 1u/pack



**Código: DAD0061**

Dado de impacto delgado TopTul.  
Medida: 1/2x21mm.

REF.: 1u/pack



**Código: DAD006**

Dado de impacto delgado TopTul.  
Medida: 1/2x22mm.

REF.: 1u/pack



**Código: DAD016**

Dado de impacto 1".  
Medida: 24mm

REF.: 1u/pack



**Código: DAD018**

Dado de impacto 1".  
Medida: 27mm

REF.: 1u/pack



**Código: DAD027**

Dado de impacto 1".  
Medida: 28mm.

REF.: 1u/pack



**Código: DAD020**

Dado de impacto 1".  
Medida: 30mm.

REF.: 1u/pack



**Código: DAD002**

Dado de impacto 1".  
Medida: 32mm.

REF.: 1u/pack



**Código: DAD001**

Dado de impacto 1".  
Medida: 33mm.

REF.: 1u/pack



**Código: DAD025**

Dado de impacto 1".  
Medida: 34mm.

REF.: 1u/pack



**Código: DAD019**

Dado de impacto 1".  
Medida: 35mm.

REF.: 1u/pack



**Código: DAD021**

Dado de impacto 1".  
Medida: 36mm.

REF.: 1u/pack



**Código: DAD017**

Dado de impacto 1".  
Medida: 38mm.

REF.: 1u/pack



**Código: DAD014**

Dado de impacto 1".  
Medida: 41mm.

REF.: 1u/pack



**Código: DAD023**

Dado de impacto 1".  
Medida: cuadro 17.

REF.: 1u/pack



**Código: DAD022**

Dado de impacto 1".  
Medida: cuadro 19.

REF.: 1u/pack



**Código: DAD015**

Dado de impacto 1".  
Medida: cuadro 21.

REF.: 1u/pack



**Código: DAD024**

Reductor de impacto TopTul.  
Medida: 1" a 3/4".

REF.: 1u/pack



**Código: DAD0241**

Reductor de impacto TopTul.  
Medida: 3/4" a 1/2".

REF.: 1u/pack



**Código: DAD0242**

Reductor de impacto TopTul.  
Medida: 3/4" a 1".

REF.: 1u/pack

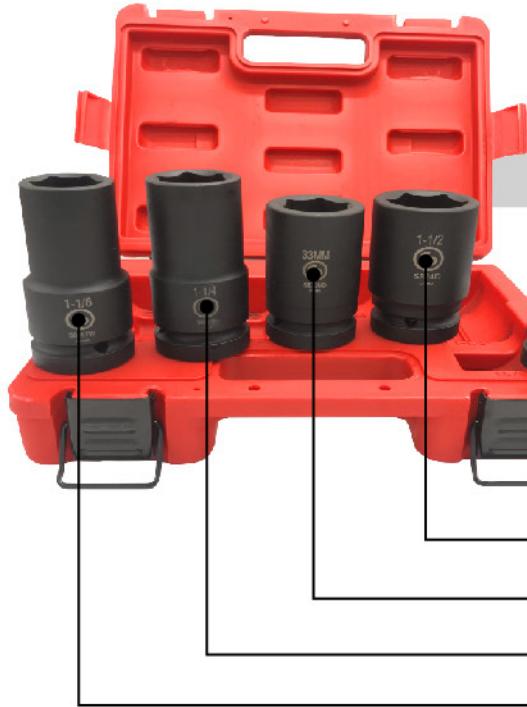

**Código: DAD026**

Set de dados de impacto  
Chicago Pneumatic estuche plástico.

REF.: 5Pcs/pack

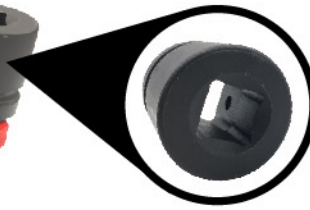

21mm

38mm

33mm

32mm

28mm



**Código: HRM004**

Multiplicador de fuerza  
Dados: 33mm y 32mm.

REF.: 1u/pack



**Código: DAD010**

Set de dados de impacto  
buffalo estuche plastico.  
REF.: 10Pcs/pack



**Código: HEN052**

Filtro regulador y lubricador  
buffalo de 1/4"  
REF.: 1u/pack



**Código: HEN053**

Filtro regulador y lubricador  
buffalo de 1/2"  
REF.: 1u/pack



# O - RINGS

## Código: ORG003

O-Ring224T 1300/1400-24  
Diam 6.84mm

REF.: 1u/pack

## Código: ORG002

O-Ring225T 15.5/17.5X25  
Diam 6.84mm

REF.: 1u/pack

## Código: ORG001

O-Ring 20/23/25-26.5x25  
25" Diam 9.78mm

REF.: 1u/pack

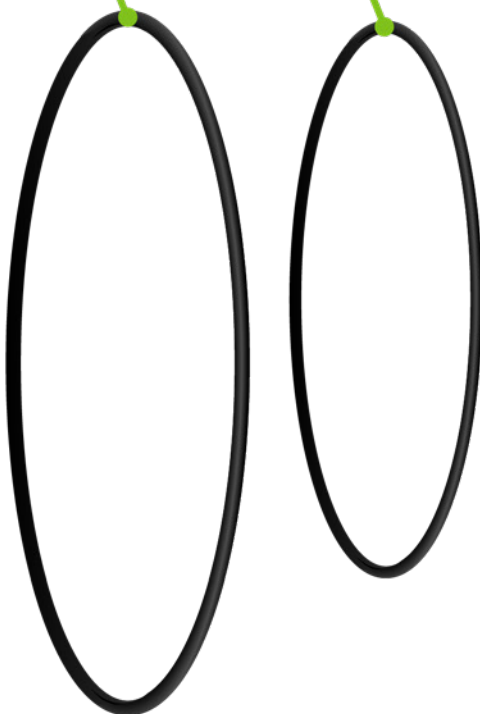

**NUEVO**



**BUFFALO**

**COLOR QUE INDICARA  
FACILMENTE EL  
ESTADO DE LA LLANTA**

**CÓDIGO:  
MDP014**

**TAMAÑO COMPACTO DE 9cm**

**PAGINA 53**

# HERRAMIENTAS DE AIRE Y MEDICIÓN



[www.lavalvula.com.ec](http://www.lavalvula.com.ec)

@lavalvulaec





**Código: MDP001**

Medidor de profundidad Milton metálico.

REF.: 1u/pack



**Código: MDP002**

Professional rubber vulk. Medidor de profundidad.

REF.: 1u/pack



**Código: MDP003**

Medidor de profundidad metálico plano.

REF.: 1u/pack



**Código: MDP004**

Medidor de profundidad digital DILL.

REF.: 1u/pack



**Código: MDP005**

Medidor de profundidad con color Buffalo.

REF.: 1u/pack



**Código: MDP006**

Medidor de profundidad para llantas OTR.

REF.: 1u/pack



**Código: MPP007**

Medidor de profundidad tipo milton metálico

REF.: 1u/pack



**Código: INF009**

Inflador negro cabeza recta Medida: 350mm.

REF.: 1u/pack



**Código: INF005**

Inflador con manometro airforce

REF.: 1u/pack



**Código: INF007**

Inflador - medidor ECG019

REF.: 1u/pack



**Código: INF012**

Inflador - medidor verde ECG-019.

REF.: 1u/pack



**Código: INF010**

Inflador - medidor digital COSENG

REF.: 1u/pack



**Código: INF013**

Inflador - medidor bayoneta ECG-028.

REF.: 1u/pack



**Código: INF016**

INFLADOR DIGITAL Medida: 350mm.

REF.: 1u/pack



**Código: INC001**

Inchador de aire  
AGRICOLA-OTR 8mm x 16mm

REF.: 1u/pack



**Código: INC002**

Inchador de aire 1/4"  
Para acople EAC - 007

REF.: 1u/pack



**Código: INC003**

Inchador de aire  
Para manguera 6mm x 16mm

REF.: 1u/pack



**Código: INC004**

Inchador de aire  
redondo con clip 8mm x 25mm

REF.: 1u/pack



**Código: INC005**

Inchador de aire  
Para manguera 8mm x 20mm

REF.: 1u/pack



**Código: MED014**

Medidor de aire pequeño  
0-50 Psi

REF.: 1u/pack



**Código: MED004**

Medidor de aire cabeza curva  
barra metálica, 10-160 Psi

REF.: 1u/pack



**Código: MED005**

Medidor de aire cabeza recta  
barra metálica. 10-150 Psi

REF.: 1u/pack



**Código: MED007**

Medidor de aire digital  
TG002 2-99.5 Psi

REF.: 1u/pack



**Código: MED010**

Medidor de aire digital 4 en 1

REF.: 1u/pack



**Código: MED006**

Medidor de aire Rubber Vulk  
10-150 Psi

REF.: 1u/pack

# LLAVES DE RUEDA



[www.lavalvula.com.ec](http://www.lavalvula.com.ec)

@lavalvulaec

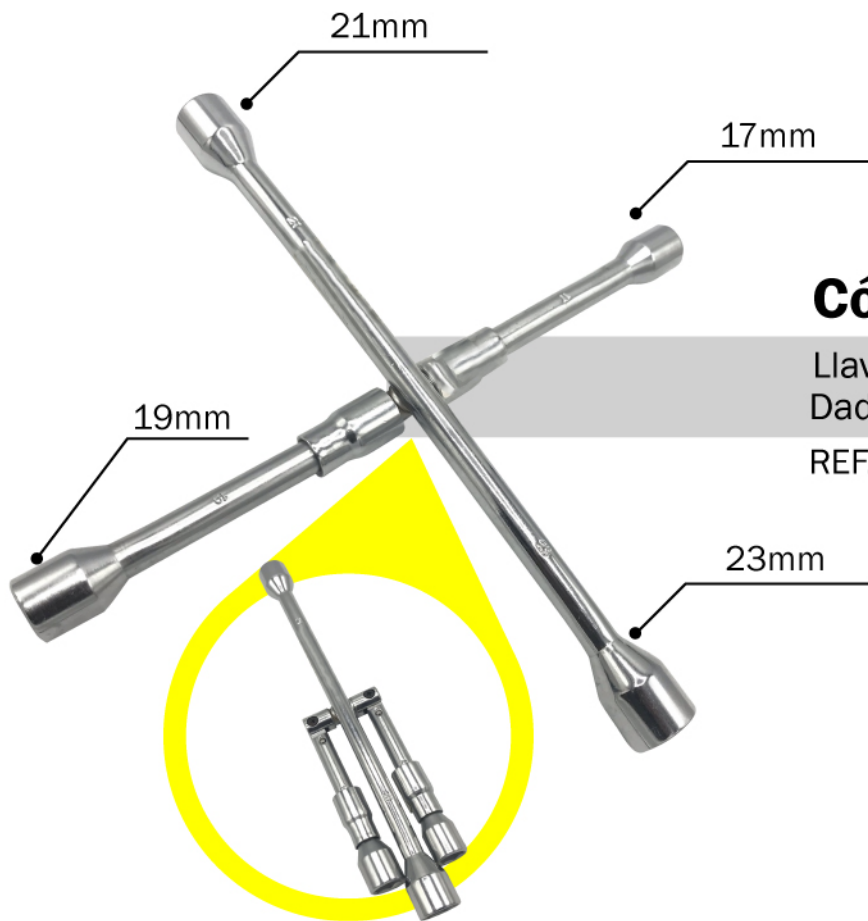

**Código: LLA002**

Llave de rueda desarmable.  
Dados 17 - 19 - 21 - 23 mm.

REF.: 1u/pack

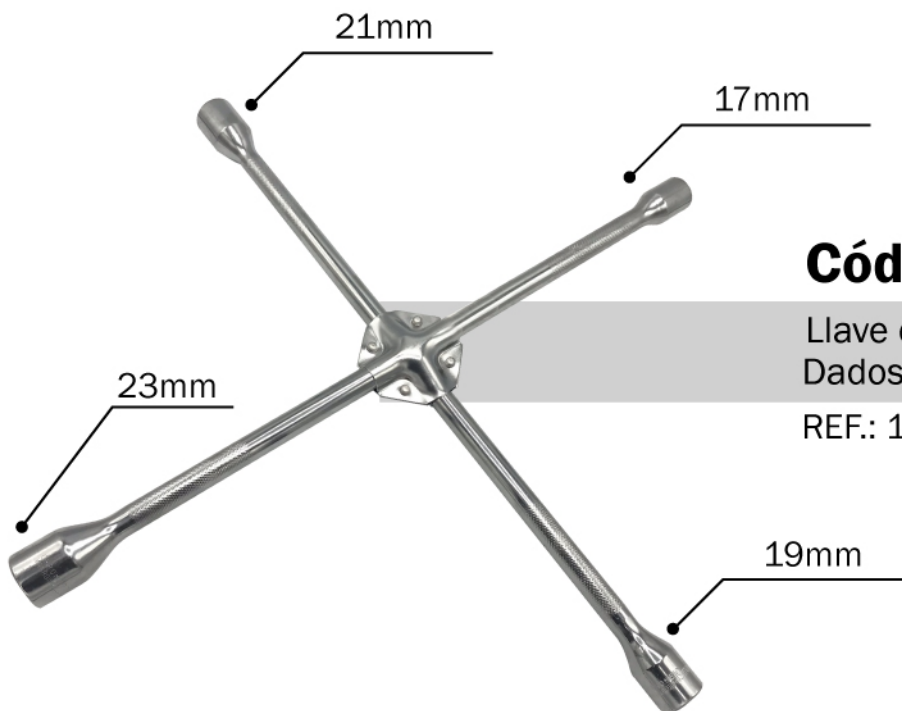
**Código: LLA003**

Llave de rueda 20" reforzada.  
Dados 17 - 19 - 21 - 23 mm.

REF.: 1u/pack

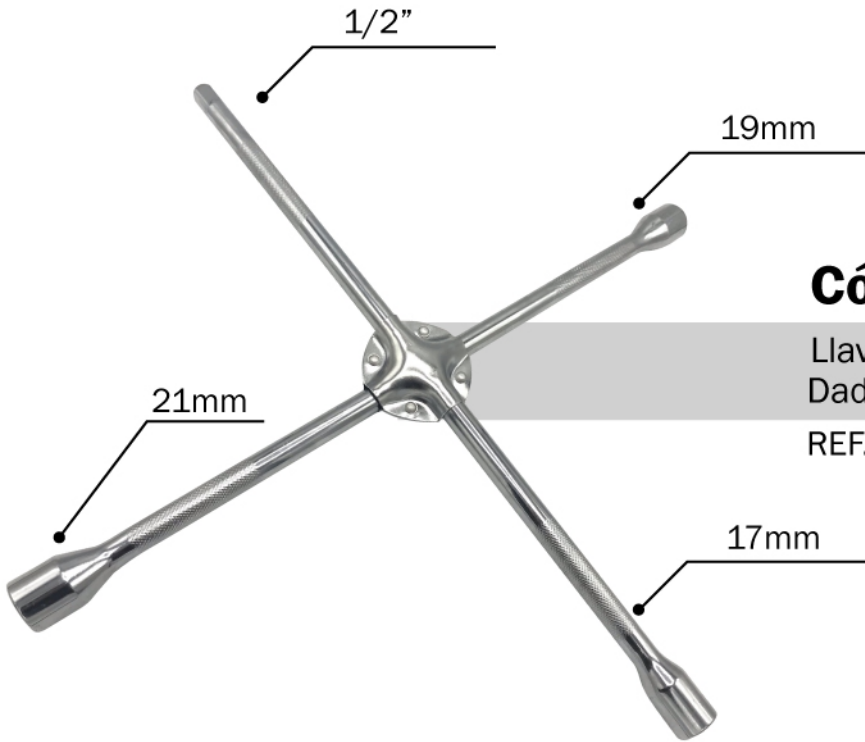

**Código: LLA006**

Llave de rueda para taller.  
Dados 17 - 19 - 21 mm - 1/2".

REF.: 1u/pack



**Código: LLA005**

Kit llave de rueda tipo "L"  
17x19mm - 21x23mm.

REF.: 1u/pack





### Código: LLA004

Llave de rueda tipo "L"  
Dado 17mm.

REF.: 1u/pack

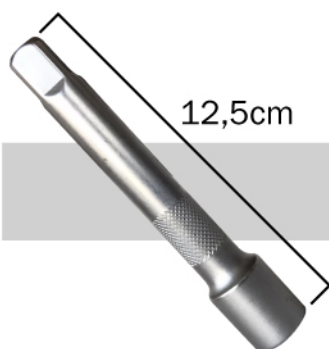

12,5cm

### Código: HER008

Extensión de llave.  
1/2" x 12,5cm.

REF.: 1u/pack

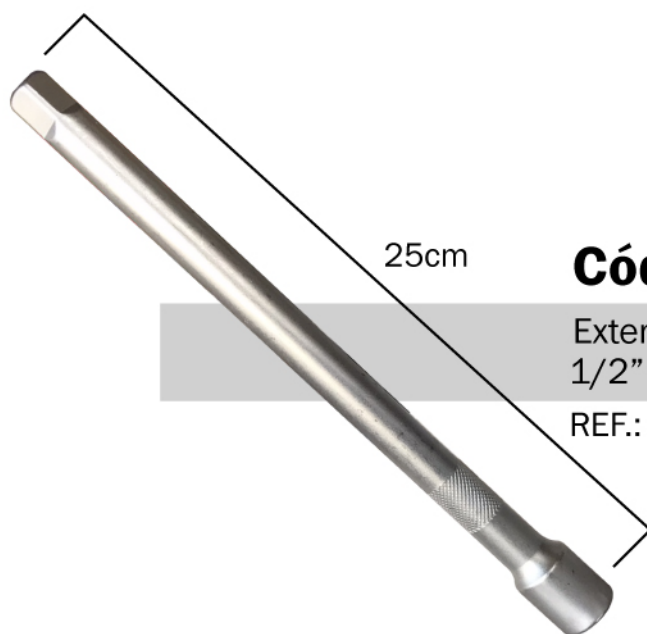

25cm

### Código: HER009

Extensión de llave.  
1/2" x 25cm

REF.: 1u/pack



# MANGUERAS

**MILTON INDUSTRIAL**  
1624-1

## FLEX HOSE

UNA ALTERNATIVA LIGERA Y ULTRA FLEXIBLE A LA MANGUERA DE GOMA  
ALTERNATIVE LÉGÈRE SUPER SOUPLE AUX BOYAUX EN CAOUTCHOUC

MANTIENE SU FLEXIBILIDAD INCLUSO A UNA TEMPERATURA DE -40°F  
HASTA UN 50% MÁS LIGERA QUE LA GOMA  
JUSQU'À 50% PLUS LÉGERE

**25 ft**  
**3/8" ID**

**200**  
MAX PSI WP

**-40°F**

**MILTON**  
MA3835OR

**35 ft.**  
**3/8 in.**

## COBRA FLEX

PVC HÍBRIDO PRIMA  
PVC HYBRIDE PREMIUM

MANGUERA DE AIRE  
LE FLEXIBLE D'AIR

EXCEPCIONAL FLEXIBILIDAD PARA TODO TIPO DE CLIMA  
PERMANECE FLEXIBLE A -40°F to 140°F  
LIGERO PERO RESISTENTE  
RESISTE TORCEDURAS, PLANA  
RACORES EN LATÓN MACIZO DE 1/4" NPT  
SOUPLESE EXTRÊME EN TOUT TEMPS  
RESTE SOUPLE JUSQU'À -40°F to 140°F  
LÉGERE ET POURTANT DURABLE  
RESISTE À UN VRIILLAGE, REPOSE À PLAT  
RACCORDS EN LAITON MASSIF 1/4 PO NPT

2 AÑOS DE GARANTÍA  
2 AN DE GARANTIE

MILTON - PRECAUCIÓN - RIESGO DE EXPLOSIÓN - NO UTILICE MAS DE 13.6 BAR - 35320 - 6.35mm ID - NYLON - ATTENTION - RISQUE D'EXPLOSION - NE PAS UTILISER PLUS DE 13.6 BAR - 35320 - 6.35mm ID - NYLON - CAUTION - RISK OF BURSTING - DO NOT USE ABOVE 200 PSI - 35320 - 6.35mm ID - NYLON - PRECAUCIÓN - RIESGO DE EXPLOSIÓN - NO UTILICE MAS DE 13.6 BAR - 35320 - 6.35mm ID - NYLON - ATTENTION - RISQUE D'EXPLOSION - NE PAS UTILISER PLUS DE 13.6 BAR - 35320 - 6.35mm ID - NYLON - CAUTION - RISK OF BURSTING - DO NOT USE ABOVE 200 PSI - 35320 - 6.35mm ID - NYLON





**Código: MAN012**

Manguera Milton Cobra Flex 300Psi  
Medida: 3/8" x 10.67m.

REF.: 1u/pack

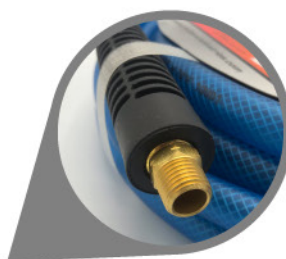

**Código: MAN013**

Manguera Milton Flex Hose 200Psi  
Medida: 3/8" x 7.6m.

REF.: 1u/pack

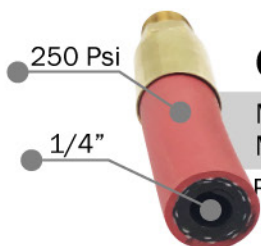

**Código: MAN014**

Manguera Milton 250Psi  
Medida: 1/4" x metros.

REF.: 1u/pack

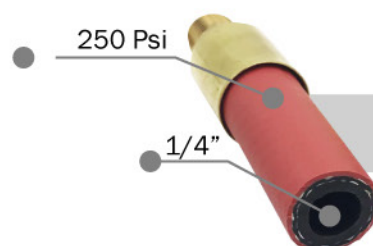

**Código: MAN015**

Manguera Milton 250Psi  
Medida: 3/8" x metros.

REF.: 1u/pack

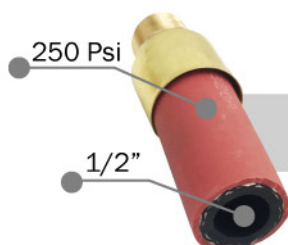

**Código: MAN016**

Manguera Milton 250Psi  
Medida: 1/2" x metros.

REF.: 1u/pack



**Código: MAN009**

Manguera Milton 200Psi  
Medida: 3/8" x 15.24m.

REF.: 1u/pack

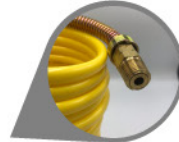

**Código: MAN010**

Manguera Milton 200Psi  
Medida: 1/4" x 7.62m.

REF.: 1u/pack



**Código: MAN011**

Manguera Amflo 200Psi  
Medida: 1/4" x 7.62m.

REF.: 1u/pack

**Código: MAN017**

Manguera de riel auto retractil.  
 300Psi.  
 Medida: 1/2" x 15,25m.

REF.: 1u/pack

**Código: MAN018**

Manguera de riel auto retractil.  
 300Psi.  
 Medida: 3/8" x 15,25m.

REF.: 1u/pack

**Código: MAN030**

Repuesto tope para manguera  
 1/2"

REF.: 1u/pack

1/2"

**Código: MAN031**

Repuesto tope para manguera  
 3/8"

REF.: 1u/pack

1/2"

# PALANCAS DE MONTAJE Y DESMONTAJE



[www.lavalvula.com.ec](http://www.lavalvula.com.ec)  
[@lavalvulaec](https://www.instagram.com/lavalvulaec)



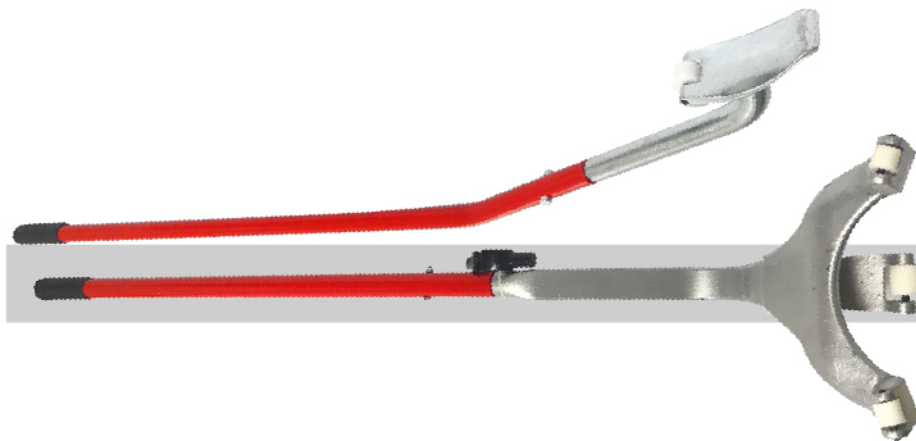

**Código: HRM011**

Set de palancas TNT  
montado - desmontado.

REF.: 2u/pack

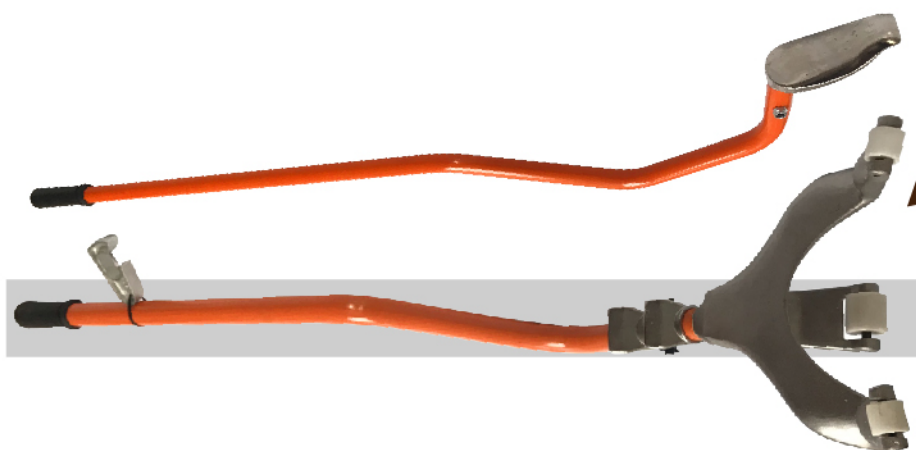

**Código: HRM021**

Set de palancas TNT  
montado - desmontado.

REF.: 2u/pack

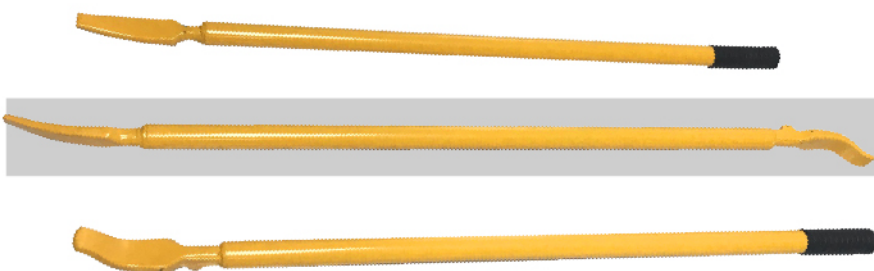

**Código: HRM018**

Set de 3 palancas  
montado - desmontado.

REF.: 3u/pack



**Código: HRM019**

Set de 2 palancas  
montado - desmontado.

REF.:2u/pack



**Código: HRM025**

Set de 2 palancas  
montado - desmontado.

REF.:2u/pack

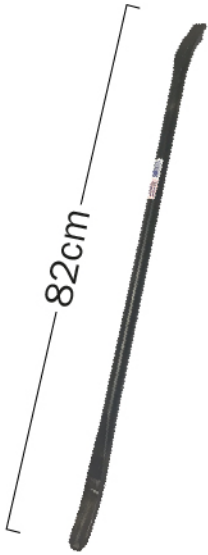

**Código: HER013**

Palanca continental KenTool.  
Medida: 82cm.

REF.: 1u/pack



**Código: HER014**

Palanca continental KenTool.  
Medida: 40cm.

REF.: 1u/pack



**Código: HER018**

Palanca continental KenTool.  
Medida: 93cm.

REF.: 1u/pack



**Código: HER001**

Palanca continental TOPTUL.  
Medida: 21" / 54cm.

REF.: 1u/pack

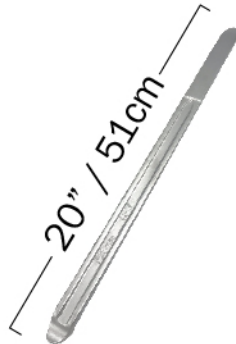

**Código: HER010**

Palanca continental.  
Medida: 20" / 51cm.

REF.: 1u/pack



**Código: HER011**

Palanca continental.  
Medida: 16" / 40,6cm.

REF.: 1u/pack



**Código: HER017**

Palanca continental.  
Medida: 28" / 72cm.

REF.: 1u/pack



**Código: HER021**

Palanca continental.  
Medida: 24" / 61cm.

REF.: 1u/pack



**Código: HER022**

Palanca continental.  
Medida: 20" / 51cm.

REF.: 1u/pack

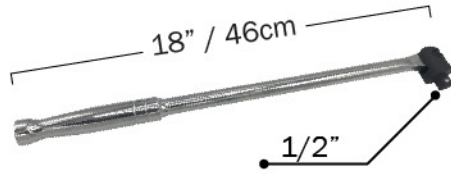

**Código: HER016**

Palanca de fuerza 1/2".  
 Medida: 18" / 46cm.

REF.: 1u/pack

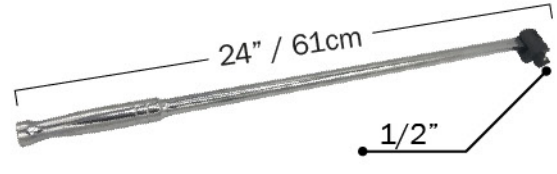
**Código: HER014**

Palanca de fuerza 1/2".  
 Medida: 24" / 61cm.

REF.: 1u/pack

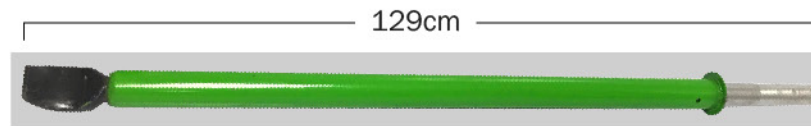
**Código: HER006**

Palanca destalonador de llantas  
 Medida: 129cm a 258 cm

REF.: 1u/pack

**Código: HRM012**

Tanque entalonador 5gl  
 Entrada de aire 1/4".

REF.: 1u/pack

**Código: HRM020**

Tanque entalonador 10gl  
 Entrada de aire 1/4".

REF.: 1u/pack



**Código: COM001**

Comprimidor de resortes.

REF.: 1u/pack



**Código: PIN001**

Destalonador de llantas manual de plastico.

REF.: 1u/pack



**Código: PIN002**

Destalonador de llantas manual de plastico

REF.: 1u/pack



# GATAS



www.lavalvula.com.ec  
@lavalvulaec





### Código: GAT027

Gata de perfil bajo doble piston.  
capacidad de 3Ton.

REF.: 1u/pack



### Código: GAT022

Gata BP doble piston.  
capacidad de 3Ton.

REF.: 1u/pack



**Código: GAT012**

Gata tipo botella 4Ton.

REF.: 1u/pack



**Código: GAT013**

Gata tipo botella 6 Ton.

REF.: 1u/pack



**Código: GAT023**

Gata tipo botella 20 Ton.

REF.: 1u/pack

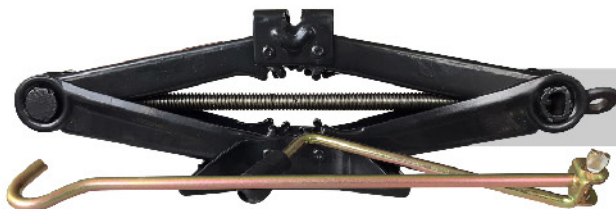

**Código: GAT006**

Gata tipo tijera 1.5 Ton.

REF.: 1u/pack

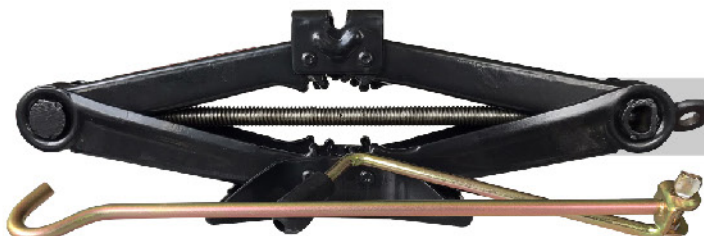

**Código: GAT007**

Gata tipo tijera 2 Ton.

REF.: 1u/pack



### Código: GAT008

Gata portatil.  
capacidad de 2Ton.

REF.: 1u/pack



### Código: GAT026

Gata 3Ton para talleres.  
capacidad de 3Ton.

REF.: 1u/pack



**Código: GAT028**

Gata neumática.  
capacidad de 3Ton.

REF.: 1u/pack



**Código: GAT013**

Soporte ajustable  
de 3 Ton.

REF.: 2u/pack



**Código: GAT013**

Soporte ajustable  
de 6 Ton.

REF.: 2u/pack



**Código: CAM001**

Camilla grande de 4 ruedas con almohadilla.

REF.: 1u/pack

# CAMILLAS



**Código: CAM002**

Camilla grande de 6 ruedas con linterna y almohadilla.

REF.: 1u/pack



# Relabradora HRM026-HIGH POWER



Consumo: 370 W  
Regulador de temperatura: Perilla giratoria  
Tamaño de cables: 1,75 m

Aumento gradual de temperatura para el mejor ajuste.  
Cuenta con gran durabilidad y La más sofisticada regulación de temperatura cercana al 1%.



# Relabradora HRM027 - HIGH TECH



Tamaño de cables: 1,75 m  
Regulador de temperatura: Digital  
Consumo: 500 W

Teclas integradas en la parte delantera para el control de temperatura más preciso. La más sofisticada, regulación de temperatura cercana al 1% y cuenta con modo de espera cuando no está en uso.



# Relabradora

## PS15 - Standard HRM028



Consumo: 370 W  
Regulador de temperatura: Perilla giratoria  
Tamaño de cables: 1,75 m

Con 4 niveles de calor y una posición cero. Cuenta con gran durabilidad y la más sofisticada, regulación de temperatura cercana al 1%.



# Relabradora

## PS15 - Truckstar Plus HRM029



Tamaño de cables: 1,75 m  
Regulador de temperatura: Digital  
Consumo: 500 W

Teclas integradas en la parte delantera para el control de temperatura más preciso. La más sofisticada, regulación de temperatura cercana al 1% y cuenta con modo de espera cuando no está en uso.



# RELABRADORAS



  
[www.lavalvula.com.ec](http://www.lavalvula.com.ec)  
[@lavalvulaec](https://twitter.com/lavalvulaec)  
 



Dirección: Calderón, calle Sicilia OE5-47 entre Derby y Nápoles



**Código: HRM008**

Marcador de llantas Elrick.  
Voltaje: 110v -220v.  
REF.: 1u/pack

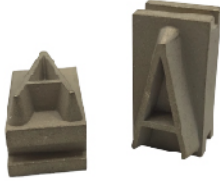

**Código: HRM0081**

Letras por separado  
Letra: A  
REF.: 1u/pack

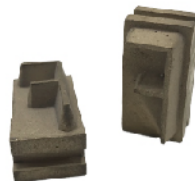

**Código: HRM0081**

Letras por separado  
Letra: F  
REF.: 1u/pack



**Código: HRM0081**

Letras por separado  
Letra: J  
REF.: 1u/pack



**Código: HRM0081**

Letras por separado  
Letra: N  
REF.: 1u/pack



**Código: HRM0081**

Letras por separado  
Letra: R  
REF.: 1u/pack

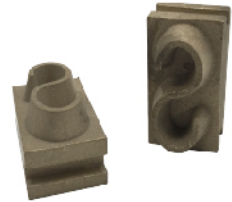

**Código: HRM0081**

Letras por separado  
Letra: S  
REF.: 1u/pack



**Código: HRM0081**

Letras por separado  
Letra: V  
REF.: 1u/pack



**Código: HRM0081**

Letras por separado  
Letra: X  
REF.: 1u/pack

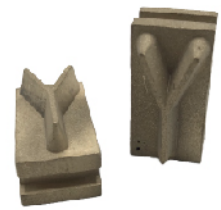

**Código: HRM0081**

Letras por separado  
Letra: Y  
REF.: 1u/pack

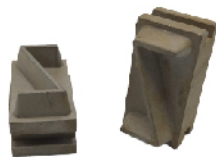

**Código: HRM0081**

Letras por separado  
Letra: Z  
REF.: 1u/pack



**Código: HRM0082**

Ser de letras para marcador  
de llantas A-Z.  
REF.: 26u/pack



**Código: HRM006**

Relabradora de mano Ideal Knives.  
Voltaje: 110v - 120v.  
Consumo: 250w.

REF.: 1u/pack



**Código: HRM023**

Relabradora con temperatura ajustable.  
Voltaje: 220v.  
Consumo: 350w.

REF.: 1u/pack

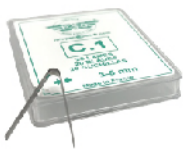

**Código: CUC001**

Cuchillas relabradoras.  
Modelo: C1 3-5mm.  
REF.: 20u/pack



**Código: CUC002**

Cuchillas relabradoras.  
Modelo: C2 6-10mm.  
REF.: 20u/pack

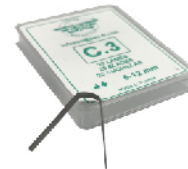

**Código: CUC003**

Cuchillas relabradoras.  
Modelo: C3 8-12mm.  
REF.: 20u/pack



**Código: CUC004**

Cuchillas relabradoras.  
Modelo: C4 10-14mm.  
REF.: 20u/pack

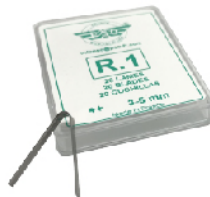

**Código: CUC009**

Cuchillas relabradoras.  
Modelo: R1 3-5mm.  
REF.: 20u/pack



**Código: CUC006**

Cuchillas relabradoras.  
Modelo: R2 5-11mm.  
REF.: 20u/pack

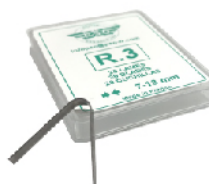

**Código: CUC007**

Cuchillas relabradoras.  
Modelo: R3 7-13mm.  
REF.: 20u/pack



**Código: CUC008**

Cuchillas relabradoras.  
Modelo: R4 16-19mm.  
REF.: 20u/pack

**Código: VMT001**

Válvula PVR70 90.  
 ø20 x 32 mm X 90°.  
 REF.: 10u/pack

**Código: VMT002**

Válvula TR430A.  
 ø14 x 33 mm.  
 REF.: 10u/pack

**Código: VMT006**

Válvula cromada VAMD-161.  
 ø16 x 34.5 mm.  
 REF.: 10u/pack

**Código: VMT007**

Válvula cromada VS8-90.  
 ø16 x 63 mm X 90°.  
 REF.: 10u/pack

**Código: VMT005**

Válvula cromada VS8-45.  
 ø16 x 53 mm X 45°.  
 REF.: 10u/pack

**Código: VMT008**

Válvula PVR50 para scooter  
 y moto ø12 x 34 mm X 90°.  
 REF.: 10u/pack

**Código: PAD111**

Pesa adhesiva de plomo BUFFALO  
 para moto. 5g / 10g.

REF.: 50u/pack

# MOTOS

## ÁREA

**Código: MEC003**

Mecha corta.  
 4" delgada.

REF.: 120u/pack



[www.lavalvula.com.ec](http://www.lavalvula.com.ec)  
 @lavalvulaec



Ø12  
Base

LA MEJOR CALIDAD

90°  
Grados

100%

**Código: VMT008**

Válvula PVR50.  
Ø12 x 34 mm X 90°.  
REF.: 10u/pack

SCOOTERS

ÁREA



**Código: PVI043**

Parche flexible R00.  
Ø 3mm.

REF.: 100u/pack

Parche universal flexible Vipal de 3 mm de diámetro. Perfecto para reparar pequeños daños en las llantas



[www.lavalvula.com.ec](http://www.lavalvula.com.ec)  
[@lavalvulaec](https://www.facebook.com/lavalvulaec)



# Parches Giro

Kit de parches para bicicletas. Con un tamaño extra compacto para llevar a cualquier parte.



BICICLETAS  
ÁREA



[www.lavalvula.com.ec](http://www.lavalvula.com.ec)

@lavalvulaec







[www.lavalvula.com.ec](http://www.lavalvula.com.ec)

@lavalvulaec

