

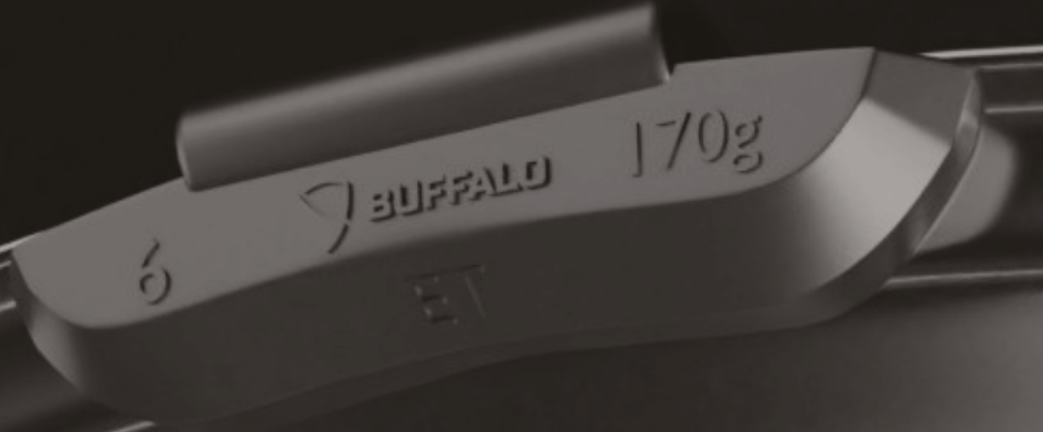

CATÁLOGO 2025
LA VALVULA®
CONSUMIBLES PARA TECNICENTROS

BUFFALO

WHEEL WEIGHTS





Calderon, Urb. Sierra Hermosa No 1
Sicilia OE5-47 y Nápoles. Quito - Ecuador
Telf.: (+593) 02-2826285 / 0986642817
www.lavalvula.com.ec
f @lavalvulaec

LA VALVULA es una empresa familiar que inició sus operaciones en el año 2011, al ver la necesidad de abastecer de insumos de vulcanización y herramientas propias del uso automotriz. La Válvula tiene como fin, proveer de insumos y herramientas a tecnicentros, distribuidores de llantas y vulcanizadores, las líneas de productos ofertados se han ido incrementando, actualmente manejamos alrededor de 400 ítems.



INDICE

| | PAG. |
|------------------------------------|--|
| Válvulas | Auto - Camioneta. _____ 1 |
| | Camión. _____ 2 |
| | Industrial Otr, Agrícola. _____ 3 |
| | Gusanillos. _____ 4 |
| | Extensiones de Válvulas. _____ 4 |
| | Empaques. _____ 4 |
| | Accesorios para válvulas. _____ 5-6 |
| | Herramientas. _____ 7 |
| | Sensores TPMS. _____ 8-9 |
| <hr/> | |
| Parches y Reparos | Parches para tubo (Flexibles). _____ 10 |
| | Parches universales para neumáticos. _____ 11 |
| | Parches radiales para neumáticos. _____ 11-12 |
| | Parches diagonales para neumáticos. _____ 12 |
| | Parches diagonales lateral para neumáticos. _____ 13 |
| | Pegantes, Selladores, Cojin. _____ 13-14 |
| | Pasta de montaje, Crayones, Mechas. _____ 15 |
| | Herramientas y Pastas. _____ 15-18 |
| <hr/> | |
| Alineación y Balanceo | Pesa de Vincha Regular. _____ 19 |
| | Pesa de Vincha MC. _____ 20 |
| | Pesa de Vincha Hierro. _____ 21 |
| | Pesa para Camión liviano. _____ 22 |
| | Pesa para Camión. _____ 23-24 |
| | Pesas adhesivas. _____ 25 |
| | Herramientas. _____ 26 |
| | Pernos, Lainas y camberimetro. _____ 27 |
| Herramientas y Repuestos. _____ 28 | |
| <hr/> | |
| Tuercas y Pernos | Tuercas Normales. _____ 29-30 |
| | Tuercas de aluminio. _____ 29 |
| | Tuercas Especiales. _____ 30 |
| | Tuercas de seguridad. _____ 31 |
| | Pernos Normales. _____ 31 |
| | Pernos Especiales. _____ 32 |
| | Pernos de seguridad. _____ 32 |
| | Llaves Hexagonales. _____ 32-33 |
| | Separadores. _____ 33 |
| Centradores. _____ 34 | |
| <hr/> | |
| Milton | Acoples y Conectores. _____ 35-36 |
| | Reductores. _____ 36 |
| | Infladores. _____ 37-39 |
| | Pulverizador y Empaques. _____ 39 |
| | Mangueras y Complementos. _____ 40-42 |

INDICE

| | PAG. |
|------------------------------------|--|
| Pistolas y Dados de impacto | Pistolas de impacto. _____ 43-45 |
| | Mantenimiento y Limpieza. _____ 45 |
| | Dados de impacto. _____ 46-50 |
| | Filtros. _____ 46-50 |
| <hr/> | |
| Aire y medición | Medidores de profundidad. _____ 51 |
| | Infladores de aire. _____ 51 |
| | Inchadores de aire. _____ 52 |
| | Medidores de aire. _____ 52 |
| <hr/> | |
| Llaves de cruz | Llaves de cruz. _____ 53-55 |
| | Extension de llaves. _____ 55 |
| <hr/> | |
| Mangueras | Mangueras. _____ 56-57 |
| | Repuestos. _____ 58 |
| <hr/> | |
| Montaje y desmontaje | Palancas de montaje y desmontaje. _____ 59 |
| | Palancas Continentales. _____ 60 |
| | Palancas de Fuerza. _____ 61 |
| | Palanca Destalonadora. _____ 61 |
| | Tanques Entalonador. _____ 61 |
| | Compresor de Resorte. _____ 62 |
| Destalonador de Llantas. _____ 62 | |

INDICE

| | PAG. |
|---------------------|---|
| Gatas | Gatas Tipo Lagarto. _____ 63 |
| | Gatas Tipo Botella. _____ 64-65 |
| | Gatas Tipo Tijera. _____ 64 |
| | Soporte para Auto y Camión. _____ 64 |
| <hr/> | |
| Relabradoras | Marcador de llantas. _____ 67 |
| | Letras Para Marcador de Llantas. _____ 67 |
| | Relabradoras. _____ 68 |
| | Cuchillas. _____ 68 |
| <hr/> | |
| Camillas | Camillas. _____ 69 |
| <hr/> | |
| O-rings | O-rings. _____ 70 |



Programación de Sensores **T.P.M.S.** Para todo Vehículo

si necesitas sensores T.P.M.S.
En la pagina **10** encontraras
variedad de sensores.



www.lavalvula.com.ec

@lavalvulaec



Pesas de balanceo
con **vincha** para
todo tipo de
Vehículo.

Podrás encontrar todo tipo
de pesas en la página **19.**



BUFFALO

Pesas de balanceo
adhesivas para
todo tipo de
Vehículo.

Podrás encontrar todo tipo
de pesas en la página **25.**



www.lavalvula.com.ec

@lavalvulaec





TPMS018 TPMS UNIVERSAL

Sensor TPMS para todo tipo de vehículo Asiáticos, Europeos, Americanos.
Sensor de presión de llantas, monitorea la presión de tus llantas en todo momento.
Maneja con total seguridad y tranquilidad.



www.lavalvula.com.ec
[@lavalvulaec](https://www.instagram.com/lavalvulaec)



VÁLVULAS Y TPMS



www.lavalvula.com.ec

@lavalvulaec



Dirección: Calderón, calle Sicilia OE5-47 entre Derby y Nápoles

Telefonos: 098 664 2817 - 02 282 6285

øD x Lmm.

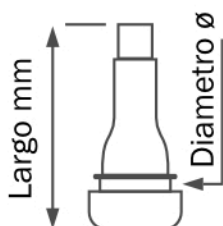

øD x Lmm X G° .

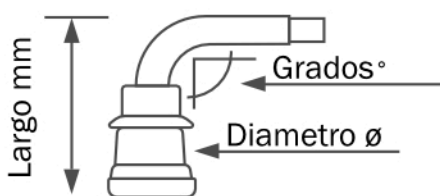
**Código: VAC001**Válvula TR413.
ø15 x 42.5 mm.

REF.: 100u/pack

**Código: VAC002**Válvula TR414.
ø15 x 48.5 mm.

REF.: 100u/pack

**Código: VAC003**Válvula TR415.
ø19.2 x 42.5 mm.

REF.: 100u/pack

**Código: VAC011**Válvula TR412.
ø15 x 33 mm.

REF.: 100u/pack

**Código: VAC004**Válvula cromada TR413 AC.
ø15 x 42.5 mm.

REF.: 100u/pack

**Código: VAC016**Válvula cromada TR413 C.
ø15 x 42.5 mm.

REF.: 100u/pack

**Código: VAC006**Válvula TR413 AC-B.
ø15 x 42.5 mm.

REF.: 100u/pack

**Código: VAC007**Válvula TR413 AC-R.
ø15 x 42.5 mm.

REF.: 100u/pack

**Código: VAC005**Válvula TR413 AC-Y.
ø15 x 42.5 mm.

REF.: 100u/pack

**Código: VAC015**Válvula TR413 AC-P.
ø15 x 42.5 mm.

REF.: 100u/pack

**Código: VAC014**Válvula TR413 AC-G.
ø15 x 42.5 mm.

REF.: 100u/pack

**Código: VAC008**Válvula TR414 AC-Y.
ø15 x 48.5 mm.

REF.: 100u/pack

**Código: VAC009**Válvula metálica V5.
ø14 x 48 mm.

REF.: 50u/pack

**Código: VAC013**Válvula metálica V3.
ø14 x 33 mm.

REF.: 100u/pack

**Código: VAC017**Válvula TV25AL.
ø15 x 25mm X 84° .

REF.: 1u/pack

**Código: VAC010**Kit válvula invisible V007.
ø11.5 - 16 x 24 mm.

REF.: 4u/pack



Código: VCA001

Válvula pequena TR435.
ø19 x 34 mm

REF.: 10u/pack



Código: VCA002

Válvula TR500 aro artillero.
ø19 x 55 mm

REF.: 10u/pack



Código: VCA003

Válvula curva TR572-27.
ø19 x 100 mm X 90°.

REF.: 50u/pack



Código: VCA004

Válvula TR573 aro artillero.
ø19 x 115 mm

REF.: 50u/pack



Código: VCA006

Válvula V320-4.
ø16 x 90 mm X 27°.

REF.: 50u/pack



Código: VCA007

Válvula V320-4 cromada.
ø16 x 90 mm X 27°.

REF.: 50u/pack



Código: VCA008

Válvula V320-6.
ø16 x 115 mm X 27°.

REF.: 50u/pack



Código: VCA011

Válvula curva AB1390.
ø16 x 50 mm X 45°.

REF.: 50u/pack



Código: VCA014

Válvula TR 602-HP.
ø12.4 x 61.3 mm

REF.: 10u/pack



Código: VCA015

Válvula TR 802-HP.
ø17 x 66 mm

REF.: 10u/pack



Código: VCA016

Válvula cromada TR543C.
ø 16 x 35 mm X 45°

REF.: 10u/pack



Código: VCA017

Válvula curva TR570C-90.
ø19 x 84 mm X 90°.

REF.: 10u/pack



Código: VCA018

Válvula MS70-7.
ø 16 x 72 mm X 5°.

REF.: 10u/pack



Código: VCA019

Válvula TR573c-90.
ø 19 x 115 mm X 90°.

REF.: 10u/pack



Código: VCA020

Válvula cromada 555D.
ø 16 x 92 mm X 75°.

REF.: 10u/pack



Código: VEC001

Válvula TR218A.
ø 27 x 55 mm.
REF.: 10u/pack



Código: VEC002

Válvula TR220A.
ø 35.5 x 72 mm.
REF.: 10u/pack



Código: VEC003

Válvula TR618A.
ø 22.5 x 30 mm.
REF.: 10u/pack



Código: VEC014

Válvula TR618.
ø 22.5 x 56 mm.
REF.: 10u/pack



Código: VEC004

Válvula curva larga TR621A.
ø 22.5 x 93 mm X 65°.
REF.: 10u/pack



Código: VEC006

Válvula TRJ650-03.
ø 31 x 79 mm X 80°.
REF.: 10u/pack



Código: VEC008

Válvula TRJ670-03.
ø 22.5 x 64 mm.
REF.: 10u/pack



Código: VEC007

Válvula TRJ652-03.
ø 31 x 140 mm X 80°.
REF.: 50u/pack



Código: VEC016

Válvula pequeña TR416.
ø18.5 x 40 mm
REF.: 50u/pack



Código: VCA001

Válvula pequeña TR435.
ø19 x 34 mm
REF.: 10u/pack



Código: VEC019

Válvula TR218A-P con pega .
ø18.5 x 40 mm
REF.: 50u/pack

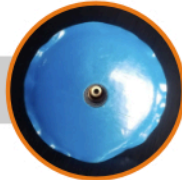

Código: VMT001

Válvula PVR70 90.
ø20 x 32 mm X 90°.
REF.: 10u/pack



Código: VMT002

Válvula TR430A.
ø14 x 33 mm.
REF.: 10u/pack



Código: VMT005

Válvula cromada VS8-45.
ø16 x 53 mm X 45°.
REF.: 10u/pack



Código: VMT006

Válvula cromada VAMD-161.
ø16 x 34.5 mm.
REF.: 10u/pack



Código: VMT007

Válvula cromada VS8-90.
ø16 x 63 mm X 90°.
REF.: 10u/pack



Código: VMT008

Válvula PVR50 para scooter y moto
ø12 x 34 mm X 90°.
REF.: 10u/pack

ACOPLE MILTON 715BK
Código: ACP001

REF.: 1u/pack
Acople rapido Milton de 1/4"
Más en la pagina 50.





Código: GUS001

Gusanillo 9002 para válvulas de auto y camioneta.

REF.: 100u/pack



Código: GUS002

Gusanillo TRJ650-03 para válvulas OTR.

REF.: 10u/pack



Código: GUS003

Adaptador de válvula macho.

REF.: 10u/pack



Código: GUS004

Adaptador de válvula hembra.

REF.: 10u/pack



Código: EXT001

Extensión de 10cm de largo cromada.

REF.: 10u/pack



Código: EXT002

Extensión de 11.5cm de largo cromada.

REF.: 10u/pack



Código: EXT003

Extensión de 13cm de largo cromada.

REF.: 10u/pack



Código: EXT004

Extensión de 14cm de largo cromada.

REF.: 10u/pack



Código: EXT012

Extensión plastica de 20cm rigida.

REF.: 10u/pack



Código: EXT006

Extensión flexible de 20cm metalica roja con soporte.

REF.: 10u/pack



Código: EXT007

Extensión flexible de 25cm metalica.

REF.: 10u/pack



Código: EXT005

Extensión flexible de 21cm negra con soporte.

REF.: 10u/pack



Código: EMP006

Empaque TR572-573 grueso.

REF.: 50u/pack



Código: EMP007

Empaque V3.20.2-3-4-5-6 delgado.

REF.: 50u/pack

VÁLVULA TR413 AC GT
Código: VAC004

REF.: 100u/pack
Válvula cromada para auto y camioneta.



**Código: CAS001**

Capuchón cromado.

REF.: 50u/pack

**Código: TAP001**

Tapa de válvula cromada.

REF.: 50u/pack

**Código: CAS002**

Capuchón azul.

REF.: 50u/pack

**Código: TAP002**

Tapa de válvula azul.

REF.: 50u/pack

**Código: CAS003**

Capuchón rojo.

REF.: 50u/pack

**Código: TAP003**

Tapa de válvula roja.

REF.: 50u/pack

**Código: CAS004**

Capuchón amarillo.

REF.: 100u/pack

**Código: TAP004**

Tapa de válvula amarilla.

REF.: 50u/pack

**Código: CAS005**

Capuchón verde.

REF.: 50u/pack

**Código: TAP005**

Tapa de válvula verde.

REF.: 50u/pack

**Código: CAS006**

Capuchón morado.

REF.: 50u/pack

**Código: TAP006**

Tapa de válvula morada.

REF.: 50u/pack

**Código: TAP007**

Tapa de válvula plástica negra.

REF.: 100u/pack

**Código: TAP008**

Tapa de válvula cromada nitrógeno.

REF.: 100u/pack

**Código: TAP009**

Tapa de válvula aluminio plateada.

REF.: 100u/pack

**Código: TAP010**

Tapa de válvula aluminio azul.

REF.: 100u/pack

**Código: TAP011**

Tapa de válvula aluminio roja.

REF.: 100u/pack

**Código: TAP012**

Tapa de válvula aluminio amarilla.

REF.: 100u/pack

Código: TAP013



Tapa de válvula aluminio Negro.

REF.: 100u/pack



Código: TAP020

Kit tapa de válvula pequeña Chevrolet.

REF.: 4u/pack

Código: TAP021



kit tapa de válvula pequeña Hyundai.

REF.: 4u/pack

Código: TAP022



kit tapa de válvula pequeña Kia.

REF.: 4u/pack

Código: TAP023



Kit tapa de válvula pequeña Mazda.

REF.: 4u/pack

Código: TAP024



Kit tapa de válvula pequeña Nissan.

REF.: 4u/pack

Código: TAP025



Kit tapa de válvula pequeña Toyota.

REF.: 4u/pack

Código: TAP026



Kit tapa de válvula pequeña Volkswaguen.

REF.: 4u/pack

Código: TAP027



Kit tapa de válvula pequeña Ford.

REF.: 4u/pack

Código: TAP030



Kit tapa grande de válvula Momo roja.

REF.: 4u/pack

Código: TAP031



Kit tapa grande de válvula Momo negro.

REF.: 4u/pack

Código: TAP032



Kit tapa grande de válvula Ferrari roja.

REF.: 4u/pack

Código: TAP033



Kit tapa grande de válvula Ferrari negra.

REF.: 4u/pack

Código: TAP034



Kit tapa grande de válvula Sparco azul.

REF.: 4u/pack

Código: TAP035



Kit tapa grande de válvula BMW azul.

REF.: 4u/pack

Código: TAP036



Kit tapa grande de válvula 500 amarilla.

REF.: 4u/pack

Código: TAP037



Kit tapa grande de válvula WRC amarilla.

REF.: 4u/pack



Código: LEX004

Llave pescadora de válvulas.

REF.: 1u/pack

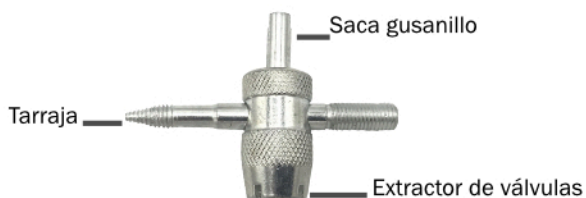

Código: TAR001

Tarraja tres en uno. Tarraja, saca gusanillo y extractor de válvula.

REF.: 1u/pack



Código: LEX001

Llave plastica extractora de válvulas color verde y azul.

REF.: 1u/pack



Llave azul incluye saca gusanillos.



Código: LEX003

Llave metalica extractora de válvulas con caucho.

REF.: 1u/pack



Caucho protector para aros.



Código: HRM017

Saca gusanillo reforzado.

REF.: 1u/pack



Código: HRM001

Saca gusanillo doble lado para gusanillos normales y OTR.

REF.: 1u/pack



Código: HRM031

Saca gusanillo tipo desarmador.

REF.: 1u/pack



Código: HRM002

Saca gusanillo corto de 10cm.

REF.: 1u/pack



Código: HRM003

Saca gusanillo largo de 17cm.

REF.: 1u/pack

KIT DECODIFICADOR TPMS

Decodificador tpms ATEQ
OBD2
Cable de red para conexión
Cable usb cargador
Cd driver para pc



Código: TPMS001

Sensor + válvula tpms Ford f150 2010-2016.

REF.: 1u/pack



Código: TPMS002

Sensor + válvula tpms Ford 35 f150 2015-2022.

REF.: 1u/pack



Código: TPMS010

Sensor + válvula tpms universal Toyota lexus pa1-014.

REF.: 1u/pack



Código: TPMS011

Sensor + válvula tpms Ford F150 2010-2014.

REF.: 1u/pack



Código: TPMS012

Sensor + válvula tpms Schader ez-zensor 33500.

REF.: 1u/pack



Código: TPMS013

Sensor + válvula tpms Great Wall Wingle 7 2019-2022.

REF.: 1u/pack



Código: TPMS014

Sensor + válvula tpms Toyota Lexus.

REF.: 1u/pack



Código: TPMS015

Sensor + válvula tpms Jac motors.

REF.: 1u/pack



Código: TPMS016

Sensor + válvula tpms Haval H6.

REF.: 1u/pack



Código: TPMS017

Sensor + válvula tpms Haval h7/h9.

REF.: 1u/pack



Código: TPMS018

Sensor + válvula tpms UNIVERSAL.

REF.: 1u/pack



Código: TPMS020

Válvula tpms tr413 Schrader ford.

REF.: 1u/pack



Código: TPMS028

Válvula tpms tr413-2 para sensor.

REF.: 1u/pack



Código: TPMS029

Válvula tpms tr413-3 para sensor.

REF.: 1u/pack



Código: TPMS021

Válvula 14 auto.

REF.: 1u/pack



Código: TPMS022

Válvula tpms alligator Snap-in valve clip-pin.

REF.: 1u/pack



Código: TPMS024

Válvula 12 auto.

REF.: 1u/pack



Código: TPMS025

Válvula tr413 Ford original.

REF.: 1u/pack



Código: TPMS026

Válvula 10 f-150 aluminio.

REF.: 1u/pack



Código: TPMS027

Válvula cromada tpms-11 base redonda.

REF.: 1u/pack



VAC019



VAC020



VAC021



VAC018



VAC023



VAC022

PERNOS Y TUERCAS

Pernos y tuercas de seguridad, especiales y normales para todo tipo de aros. más información en la página **31**





DECODIFICADOR TPMS

Diagnostica, activa y programa TPMS80 es compatible con el 98% de marcas Americanas, Europeas y Asiaticas.

Parches Giro

Kit de parches para bicicletas. Con un tamaño extra compacto para llevar a cualquier parte.



BICICLETAS

ÁREA



www.lavalvula.com.ec

@lavalvulaec



PARCHES Y PEGAS



www.lavalvula.com.ec

@lavalvulaec



Dirección: Calderón, calle Sicilia OE5-47 entre Derby y Nápoles

Telefonos: 098 664 2817 - 02 282 6285



Código: PVI043

Parche flexible R00.
ø30mm.

REF.: 100u/pack



Código: PVI101

Parche flexible R01.
ø40mm.

REF.: 120u/pack



Código: PVI002

Parche flexible R02.
ø50mm.

REF.: 40u/pack



Código: PVI103

Parche flexible R03.
ø60mm.

REF.: 65u/pack



Código: PVI004

Parche flexible R04.
ø80mm.

REF.: 40u/pack



Código: PVI005

Parche flexible R05.
ø100mm.

REF.: 25u/pack



Código: PVI006

Parche flexible R06.
ø120mm.

REF.: 25u/pack



Código: PCE000

Parche flexible.
ø30mm.

REF.: 150u/pack



Código: PCE001

Parche flexible.
ø40mm.

REF.: 100u/pack



Código: PCE002

Parche flexible.
ø50mm.

REF.: 64u/pack



Código: PVI022

Parche universal RT-3.
ø60mm.

REF.: 40u/pack



Código: PVI023

Parche universal VF03.
ø35mm.

REF.: 100u/pack



Código: PVI107

Parche universal VF06.
50 X 50 mm.

REF.: 80u/pack



Código: PVI025

Parche universal VF08.
67 X 67 mm

REF.: 50u/pack



Código: PVI007

Parche radial RAC10.
77x55mm.

REF.: 20u/pack



Código: PVI008

Parche radial RAC12.
115x70mm.

REF.: 10u/pack



Código: PVI009

Parche radial RAC14.
130x85 mm.

REF.: 10u/pack



Código: PVI010

Parche radial RAC15.
90x75mm.

REF.: 20u/pack

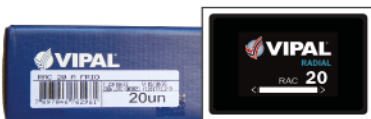

Código: PVI011

Parche radial RAC20.
120x80mm.

REF.: 20u/pack

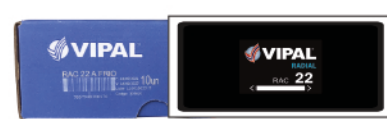

Código: PVI012

Parche radial RAC22.
165x75 mm.

REF.: 10u/pack



Código: PVI013

Parche radial RAC24.
215x75mm.

REF.: 10u/pack



Código: PVI014

Parche radial RAC25.
125x115mm.

REF.: 10u/pack



Código: PVI015

Parche radial RAC26.
260x75 mm.

REF.: 10u/pack



Código: PVI016

Parche radial RAC35.
180x130mm.

REF.: 20u/pack



Código: PVI017

Parche radial RAC40.
200x100mm.

REF.: 10u/pack



Código: PVI018

Parche radial RAC42.
260x130 mm.

REF.: 10u/pack



Código: PVI019

Parche radial RAC44.
335x130mm.

REF.: 20u/pack



Código: PVI020

Parche radial RAC45.
230x180mm.

REF.: 5u/pack



Código: PVI021

Parche radial RAC46.
440x180 mm.

REF.: 5u/pack



Código: PVI026

Parche diagonal VD01.
ø60mm.

REF.: 30u/pack



Código: PVI027

Parche diagonal VD02.
ø85mm.

REF.: 20u/pack



Código: PVI028

Parche diagonal VD03.
105 mm.

REF.: 10u/pack



Código: PVI029

Parche diagonal VD04.
135mm.

REF.: 10u/pack



Código: PVI030

Parche diagonal VD05.
165mm.

REF.: 10u/pack



Código: PVI031

Parche diagonal VD06.
245 mm.

REF.: 10u/pack



Código: PVI032

Parche diagonal VD07.
300mm.

REF.: 10u/pack



Código: PVI033

Parche diagonal VD08.
350mm.

REF.: 5u/pack



Código: PVI034

Parche diagonal VD09.
395 mm.

REF.: 5u/pack



Código: PVI035

Parche diagonal VD10.
455mm.

REF.: 3u/pack



Código: PVI026

Parche diagonal lateral VDL05.
165mm.

REF.: 10u/pack



Código: PVI027

Parche diagonal lateral VDL06.
245mm.

REF.: 10u/pack



Código: PVI028

Parche diagonal lateral VDL07.
300 mm.

REF.: 10u/pack



Código: PVI013

Parche diagonal lateral VDL08.
350mm.

REF.: 10u/pack



Código: PVI014

Parche diagonal lateral VDL09.
395mm.

REF.: 5u/pack



Código: PVI015

Parche diagonal lateral VDL10.
455 mm

REF.: 3u/pack



Código: PEG003

cemento vipal universal CV00.
lata de 163g / 5.74oz.

REF.: 1u/pack



Código: PEG013

Vulcanizante CV00-B.
lata de 171g / 6.03oz.

REF.: 1u/pack



Código: PEG004

cemento vipal universal CV01.
lata de 362g / 12.76oz.

REF.: 1u/pack



Código: PEG014

Vulcanizante vipal CV01-B.
lata de 380g / 13.40oz.

REF.: 20u/pack



Código: PEG012

cemento vipal universal CV02.
lata de 725g / 25.57oz.

REF.: 5u/pack



Código: PEG015

Vulcanizante CV02-B.
Lata de 760g / 26.80oz.

REF.: 5u/pack



Código: PEG001

Pega vipal BV-02.
tubo de 18g / 0.63oz.

REF.: 12u/pack



Código: PEG002

Pega vipal BV-03.
tubo de 32g / 1.12oz.

REF.: 6u/pack



Código: PEG010

Sellador vipal SV-01E.
lata de 400g / 14.11oz.
REF.: 1u/pack



Código: PEG016

Sellador vipal SV-02E.
lata de 400g / 14.11oz.
REF.: 1u/pack



Código: PEG009

Pega COLA VULK.
lata de 685g / 24.16oz.
REF.: 1u/pack



Código: PEG021

Pega COLA VULK.
lata de 14kg / 30.80lb.
REF.: 1u/pack



Código: PEG017

Pega VIPAFIX.
lata de 1000g / 2.20lb.
REF.: 1u/pack



Código: PEG019

Diluyente BUFPALE E.
lata de 1000ml / 33.00oz.
REF.: 1u/pack



Código: PEG024

BULPAL en espray.
lata de 400ml.
REF.: 1u/pack



Código: PEG018

Catalizador VIPAFIX 30min.
50ml / 1.6oz.
REF.: 10u/pack



Código: PEG019

Catalizador VIPAFIX 60min.
25ml / 0.8oz.
REF.: 10u/pack



Código: COJ001

Cojin vipal MB/AC 10k.
3000 x 23.5 cm.
REF.: 1u/pack

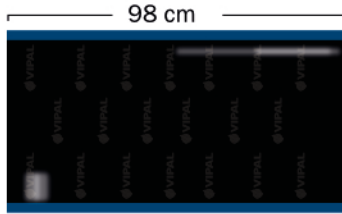

Código: COJ005

Cojin VIPAL MB/AC por metro.
23.5 x 98 cm.
REF.: 1u/pack

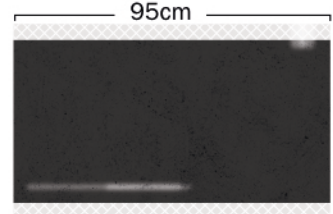

Código: COJ004

Lona para vulcanizar.
95x48 cm.
REF.: 1u/pack

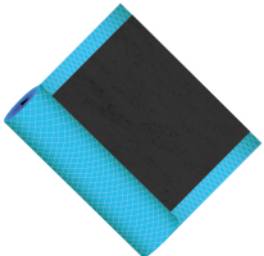

Código: COJ008

Cojin para vulcanizar.
1Kg.
REF.: 1u/pack



Código: PAS001

Pasta de montaje VIPAL.
balde de 3,6kg / 7.93lb.

REF.: 1u/pack



Código: TIZ004

Crayon amarillo VIPAL.
10x100mm.

REF.: 12u/pack



Código: MEC001

Mecha negra.
4" corta.

REF.: 60u/pack



Código: MEC003

Mecha corta.
4" delgada.

REF.: 120u/pack



Código: MEC005

Mecha corta.
4" gruesa.

REF.: 60u/pack



Código: MEC006

Mecha larga.
8" gruesa.

REF.: 25u/pack



Código: LEZ001

Kit de lezna introductora 4 en 1.
(no incluye mechas)

REF.: 1u/pack



Código: LEZ002

Lezna helicoidal desarmable
(no incluye mechas)

REF.: 1u/pack



Código: LEZ007

Lezna introductora desarmable.
(no incluye mechas)

REF.: 1u/pack



KIT DE LEZNAS METE MECHAS

Código: LEZ009

Kit mete mechas completo. Incluye dos leznas (helicoidal e introductora) pega para mechas, cuatro paquetes de mechas (5 mechas en cada uno) estilete, dos llaves hexagonales y estuche.

REF.: 27pcs/pack



Código: LEZ003

Kit de leznas mango plastico
mas 5 mechas y pega.

REF.: 1u/pack



Código: LEZ010

Kit de leznas mango metálico
mas 5 mechas y pega.

REF.: 1u/pack



Código: LEZ012

Lezna limadora mango metálico.

REF.: 1u/pack



KIT TURBINA AIR TOOL

Código: HEN001

Kit de turbina air tool 22.000 Rpm. Incluye 10 piedras para pulir (5 pcs 1/4" y 5 pcs 1/8"), 1 adaptador de piedra, 1 conector de aire 2 llaves para ensamblar y estuche.

REF.: 15pcs/pack



Código: HEN040

Turbina de aire Chicago Pneumatic CP873. 2.800Rpm.

REF.: 1u/pack



Código: HEN012

Turbina de aire con amoladora. 22.000Rpm.

REF.: 1u/pack



Código: PIE005

Adaptador de piedra de 1/4".

REF.: 1u/pack



Código: PIE001

Kit de piedras para pulir moler y desbastar.

REF.: 3u/pack



Código: PIE003

Piedra tipo disco de tungsteno.

REF.: 1u/pack



Código: PIE002

Piedra ventilada de tungsteno. pequeña.

REF.: 1u/pack



Código: PIE004

Piedra tipo bola de tungsteno.

REF.: 1u/pack



Código: PIE013

Piedra ventilada de tungsteno grande.

REF.: 1u/pack



Código: PIE014

Piedra tipo bola 40mm diametro

REF.: 1u/pack



Código: LEZ008

Punzón helicoidal mango de plastico.

REF.: 1u/pack



Código: LEZ011

Punzón para revisión de llanta mango de plastico.

REF.: 1u/pack

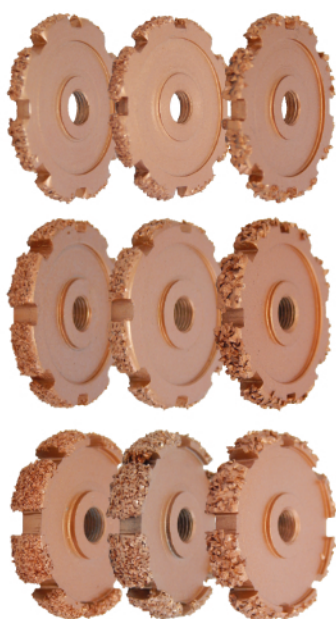
PIEDRAS DE DISCO GRIT

| Código | Medida |
|--------|---------------|
| PIE015 | #18 - 50X5mm |
| PIE016 | #18 - 50x7mm |
| PIE017 | #18 - 50x10mm |
| PIE018 | #23 - 50X7mm |
| PIE019 | #23 - 50X5mm |
| PIE020 | #23 - 50X10mm |
| PIE021 | #36 - 50X5mm |
| PIE022 | #36 - 50X7mm |
| PIE023 | #36 - 50X10mm |

PIEDRAS DE PUNTA GRIT

| Código | Medida |
|--------|---------------|
| PIE024 | #18 - 6X65mm |
| PIE025 | #23 - 6x65mm |
| PIE026 | #36 - 6x65mm |
| PIE027 | #18 - 6X102mm |
| PIE028 | #23 - 6X102mm |
| PIE029 | #36 - 6x102mm |
| PIE030 | #18 - 8x170mm |
| PIE031 | #23 - 8X170mm |
| PIE032 | #36 - 8X170mm |

FRESAS ROTATIVAS

| Código | Medida |
|--------|-------------|
| FRE002 | 3x30x60mm |
| FRE003 | 4.5x50x80mm |
| FRE004 | 6x55x90mm |
| FRE005 | 8x60x105mm |



Código: ROD001

Rodillo pequeño de 4mm.

REF.: 1u/pack



Código: ROD002

Rodillo de 6mm.

REF.: 1u/pack



Código: ROD003

Rodillo de 40mm.

REF.: 1u/pack



Código: RAS001

Raspador tipo espátula.

REF.: 1u/pack



Código: BRO001

Brocha para pasta de enlantar
plastica recta.

REF.: 1u/pack



Código: BRO002

Brocha para pasta de enlantar
plastica curva

REF.: 1u/pack



Código: PAS003

Gel concentrado TIP-TOP.
balde de 3.63kg / 8lb

REF.: 1u/pack



Código: PAS005

Gel concentrado TIP-TOP.
balde de 11.34 kg / 25 lb.

REF.: 1u/pack



Código: PAS008

Pasta de montaje TIP-TOP.
balde de 5kg.

REF.: 1u/pack



Código: PAS002

Pasta de montaje BUFFALO.
balde de 3kg / 6.61lb.

REF.: 1u/pack



SEPARADOR DE LLANTAS
Código: HEN036

separadora de llantas para parchar con
eje ajustable y soporte para herramientas.

REF.: 1U/pack





Código: HEN048

Vulcanizadora de mesa.
 Voltaje: 110v. Consumo: 500w.
 Temperatura: 145 - 165. Area de reparo: 60x60mm.

REF.: 1u/pack

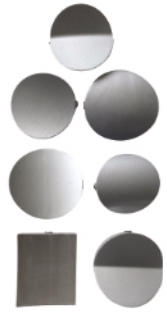

Código: HEN007

Vulcanizadora tipo prensa y platos para vulcanizar.
 Voltaje: 110v. Consumo: 1000w.
 Temperatura: 145 - 165. Area de reparo: 650x335x100mm.

REF.: 1u/pack

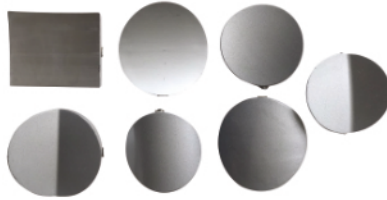

Código: HEN006

Vulcanizadora con pedestal mas platos para vulcanizar.
 Voltaje: 220v. Consumo: 1000w.
 Temperatura: 145 - 160. Area de reparo: 650x335x100mm.

REF.: 1u/pack

Código: HEN062

Vulcanizadora con pedestal.
 Voltaje: 220v. Consumo: 900w.
 Temperatura: 0 - 300. Area de reparo: 740x320x1225mm.

REF.: 1u/pack



Código: TER002

Plancha para vulcanizadora.

REF.: 1u/pack



Código: TER001

Termostato para vulcanizadora.

REF.: 1u/pack

REMA TIP TOP PEGAS



Código: PEG007

Pega Rema TIP TOP cement SC-BL
70g / 80ml.

REF.: 1U/pack



Código: PEG027

Pega Rema TIP TOP cement SC-BL
200g / 230ml.

REF.: 1U/pack



Código: PEG031

Pega Rema TIP TOP cement SC-BL
32oz/946ml.

REF.: 1U/pack

**Código: VMT001**

Válvula PVR70 90.
 ø20 x 32 mm X 90°.
 REF.: 10u/pack

**Código: VMT002**

Válvula TR430A.
 ø14 x 33 mm.
 REF.: 10u/pack

**Código: VMT006**

Válvula cromada VAMD-161.
 ø16 x 34.5 mm.
 REF.: 10u/pack

Código: VMT007

Válvula cromada VS8-90.
 ø16 x 63 mm X 90°.
 REF.: 10u/pack

**Código: VMT005**

Válvula cromada VS8-45.
 ø16 x 53 mm X 45°.
 REF.: 10u/pack

Código: VMT008

Válvula PVR50 para scooter
 y moto ø12 x 34 mm X 90°.
 REF.: 10u/pack

**Código: PAD111**

Pesa adhesiva de plomo BUFFALO
 para moto. 5g / 10g.

REF.: 50u/pack

MOTOS
ÁREA

**Código: MEC003**

Mecha corta.
 4" delgada.

REF.: 120u/pack

ALINEACIÓN Y BALANCEO



www.lavalvula.com.ec

@lavalvula



Dirección: Calderón, calle Sicilia OE5-47 entre Derby y Nápoles

Telefonos: 098 664 2817 - 02 282 6285



Pb

PESAS DE BALANCEO BUFFALO DE PLOMO CON VINCHA REGULAR

PESAS DE BALANCEO CON VINCHA

RA 1/4 - 0.25oz - 7g

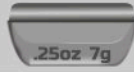

Código: PRA001

REF.: 100u/pack

RA 1/2 - 0.50oz - 14g



Código: PRA002

REF.: 100u/pack

RA 3/4 - 0.75oz - 21g

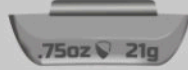

Código: PRA003

REF.: 100u/pack

RA 1 - 1.00oz - 28g



Código: PRA004

REF.: 100u/pack

RA 1 1/4 - 1.25oz - 35g



Código: PRA005

REF.: 50u/pack

RA 1 1/2 - 1.50oz - 42g



Código: PRA006

REF.: 50u/pack

RA 1 3/4 - 1.75oz - 50g



Código: PRA007

REF.: 50u/pack

RA 2 - 2.00oz - 57g



Código: PRA008

REF.: 50u/pack

RA 2 1/4 - 2.25oz - 64g



Código: PRA009

REF.: 50u/pack

RA 2 1/2 - 2.50oz / 71g



Código: PRA010

REF.: 50u/pack

RA 2 3/4 - 2.75oz - 78g



Código: PRA011

REF.: 50u/pack

RA 3 - 3.00oz / 85g



Código: PRA012

REF.: 50u/pack

RA 4 - 4.00oz / 113g



Código: PRA013

REF.: 25u/pack

RA 5 - 5.00oz / 141g



Código: PRA014

REF.: 25u/pack

RA 6 - 6.00oz / 170g



Código: PRA015

REF.: 25u/pack

Pb



PESAS DE BALANCEO BUFFALO DE PLOMO CON VINCHA MC



| | | |
|--------------------------------|--|--|
| MC 1/4 - 0.25oz - 7g | | Código: PMC001 REF.: 100u/pack |
| MC 1/2 - 0.50oz - 14g | | Código: PMC002 REF.: 100u/pack |
| MC 3/4 - 0.75oz - 21g | | Código: PMC003 REF.: 100u/pack |
| MC 1 - 1.00oz - 28g | | Código: PMC004 REF.: 100u/pack |
| MC 1 1/4 - 1.25oz - 35g | | Código: PMC005 REF.: 50u/pack |
| MC 1 1/2 - 1.50oz - 42g | | Código: PMC006 REF.: 50u/pack |
| MC 1 3/4 - 1.75oz - 50g | | Código: PMC007 REF.: 50u/pack |
| MC 2 - 2.00oz - 57g | | Código: PMC008 REF.: 50u/pack |
| MC 2 1/4 - 2.25oz - 64g | | Código: PMC009 REF.: 50u/pack |
| MC 2 1/2 - 2.50oz - 71g | | Código: PMC010 REF.: 50u/pack |
| MC 2 3/4 - 2.75oz - 78g | | Código: PMC011 REF.: 50u/pack |
| MC 3 - 3.00oz - 85g | | Código: PMC012 REF.: 50u/pack |





PESAS DE BALANCEO DE HIERRO CON VINCHA REGULAR



Fe

Fe P 1/4 - 0.25oz - 7g



Código: PHE001

REF.: 100u/pack

Fe P 1/2 - 0.50oz - 14g



Código: PHE002

REF.: 100u/pack

Fe P 3/4 - 0.75oz - 21g



Código: PHE003

REF.: 100u/pack

Fe P 1 - 1.00oz - 28g

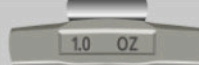

Código: PHE004

REF.: 100u/pack

Fe P 1 1/4 - 1.25oz - 35g



Código: PHE005

REF.: 50u/pack

Fe P 1 1/2 - 1.50oz - 42g

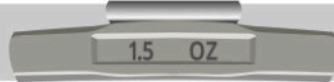

Código: PHE006

REF.: 50u/pack

Fe P 1 3/4 - 1.75oz - 50g

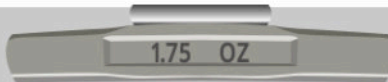

Código: PHE007

REF.: 50u/pack

Fe P 2 - 2.00oz - 57g

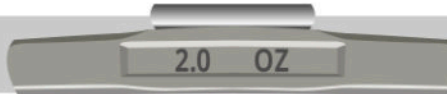

Código: PHE008

REF.: 50u/pack



PESAS DE BALANCEO DE HIERRO CON VINCHA MC



Fe MC 1/4 - 0.25oz - 7g



Código: PHD001

REF.: 100u/pack

Fe MC 1/2 - 0.50oz - 14g



Código: PHD002

REF.: 100u/pack

Fe MC 3/4 - 0.75oz - 21g



Código: PHD003

REF.: 100u/pack

Fe MC 1 - 1.00oz - 28g



Código: PHD004

REF.: 100u/pack

Fe MC 1 1/4 - 1.25oz - 35g

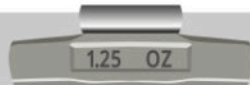

Código: PHD005

REF.: 50u/pack

Fe MC 1 1/2 - 1.50oz - 42g

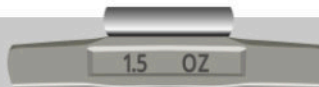

Código: PHD006

REF.: 50u/pack

Fe MC 1 3/4 - 1.75oz - 50g

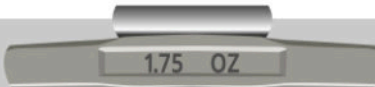

Código: PHD007

REF.: 50u/pack

Fe MC 2 - 2.00oz - 57g

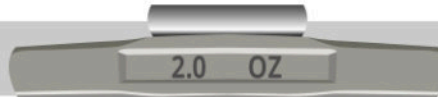

Código: PHD008

REF.: 50u/pack

Pb



PESAS DE BALANCEO BUFFALO DE PLOMO PARA CAMIÓN LIVIANO

1oz / 26g



Código: PPC001
REF.: 50u/pack

2oz / 57g



Código: PPC002
REF.: 50u/pack

3oz / 85g



Código: PPC003
REF.: 50u/pack

4oz / 113g



Código: PPC004
REF.: 25u/pack

5oz / 141g



Código: PPC005
REF.: 25u/pack

6oz / 170g



Código: PPC006
REF.: 25u/pack



**PESAS DE BALANCEO
PARA CAMIÓN LIVIANO**



Pb

PESAS DE BALANCEO BUFFALO DE PLOMO CON VINCHA ET

ET 2oz / 57g



Código: PET002

REF.: 50u/pack

ET 3oz / 85g



Código: PET003

REF.: 50u/pack

ET 4oz / 113g



Código: PET004

REF.: 25u/pack

ET 5oz / 141g



Código: PET005

REF.: 25u/pack

ET 6oz / 170g



Código: PET006

REF.: 25u/pack

ET 7oz / 196g



Código: PET007

REF.: 20u/pack

ET 8oz / 226g



Código: PET008

REF.: 20u/pack

ET 9oz / 255g



Código: PET009

REF.: 20u/pack

ET 10oz / 283g



Código: PET010

REF.: 15u/pack

ET 12oz / 351g



Código: PET012

REF.: 15u/pack

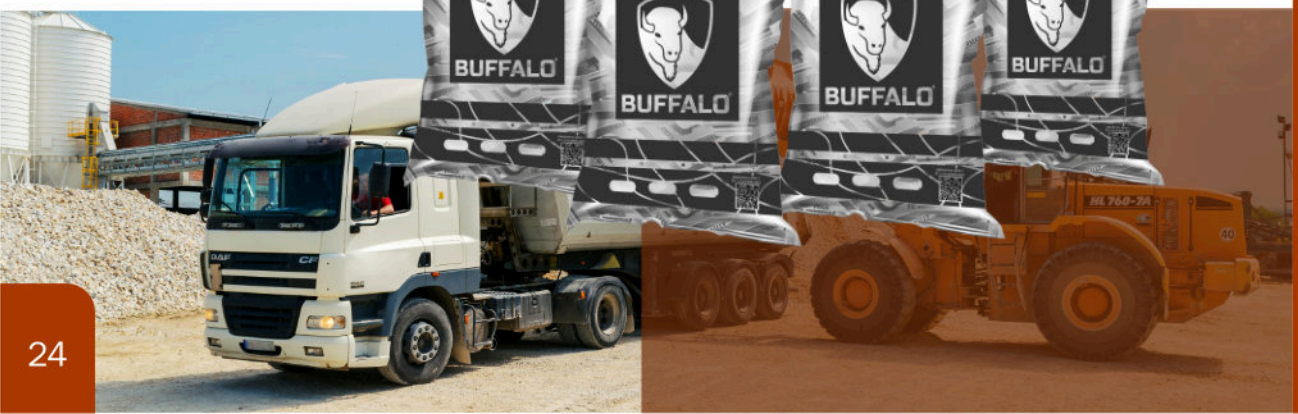



Código: PAD013

Pesa adhesiva de hierro de lujo.
7g / 0.25oz.

REF.: 50u/pack



Código: PAD016

Pesa adhesiva de hierro de lujo.
14g / 0.50oz.

REF.: 50u/pack

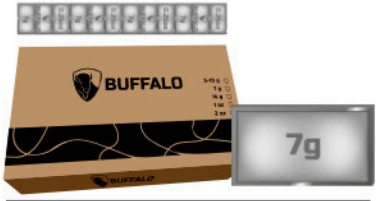

Código: PAD112

Pesa adhesiva de plomo BUFFALO.
7g / 0.25oz.

REF.: 30u/pack



Código: PAD113

Pesa adhesiva de plomo BUFFALO.
14g / 0.50oz.

REF.: 48u/pack

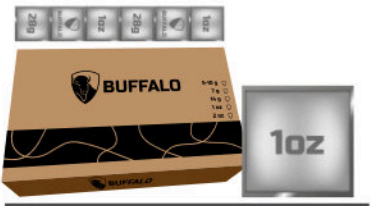

Código: PAD114

Pesa adhesiva de plomo BUFFALO
para camión 1oz / 28g.

REF.: 20u/pack



Código: PAD115

Pesa adhesiva de plomo BUFFALO
para camión 2oz / 57g.

REF.: 20u/pack

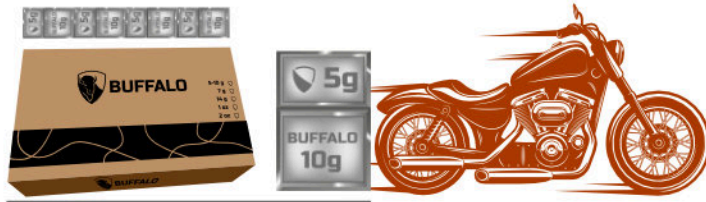

Código: PAD111

Pesa adhesiva de plomo BUFFALO
para moto. 5g / 10g.

REF.: 50u/pack



Código: PAD111

Pesa adhesiva de plomo buffalo
para moto. 5g / 10g.

REF.: 50u/pack



Código: PAD013

Pesa adhesiva de hierro de lujo.
7g / 0.25oz.

REF.: 50u/pack



Código: PAD016

Pesa adhesiva de hierro de lujo.
14g / 0.50oz.

REF.: 50u/pack

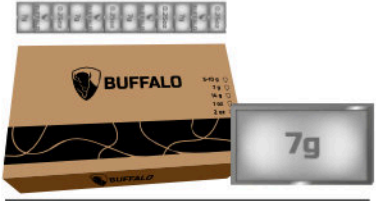

Código: PAD112

Pesa adhesiva de plomo BUFFALO.
7g / 0.25oz.

REF.: 30u/pack



Código: PAD113

Pesa adhesiva de plomo BUFFALO.
14g / 0.50oz.

REF.: 48u/pack

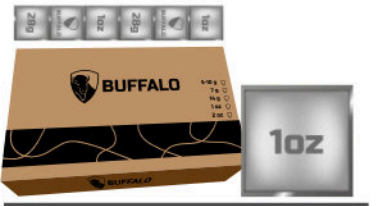

Código: PAD114

Pesa adhesiva de plomo BUFFALO
para camión 1oz / 28g.

REF.: 20u/pack



Código: PAD115

Pesa adhesiva de plomo BUFFALO
para camión 2oz / 57g.

REF.: 20u/pack

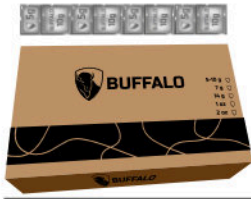

Código: PAD111

Pesa adhesiva de plomo BUFFALO
para moto. 5g / 10g.

REF.: 50u/pack



Código: PAD111

Pesa adhesiva de plomo buffalo
para moto. 5g / 10g.

REF.: 50u/pack



Código: HRM014

Martillo para pesas profesional TOPTUL.

REF.: 1u/pack



Código: HRM005

Martillo para pesas con gancho empaque rojo.

REF.: 1u/pack



Código: HRM016

Martillo KEN TOOL profesional para Peas de balanceo.

REF.: 1u/pack



Código: HRM010

Martillo para pesas empaque rojo largo.

REF.: 1u/pack



Código: HRM022

Martillo empaque rojo con punta de goma.

REF.: 1u/pack



Código: REM001

Removedor de pesas adhesivas plastico.

REF.: 1u/pack



Código: REM002

Removedor de pesas adhesivas metálico.

REF.: 1u/pack



Código: PEX001

Perno excéntrico TS 10.9
10mm

REF.: 20u/pack



Código: PEX002

Perno excéntrico TS 12.9
12mm

REF.: 20u/pack



Código: PEX003

Perno excéntrico TS10.9
13 mm

REF.: 10u/pack



Código: PEX004

Perno excéntrico TS 12.9.
14mm

REF.: 12u/pack



Código: PEX006

Perno excéntrico TS 12.9.
15mm

REF.: 10u/pack



Código: PEX007

Perno excéntrico TS12.9.
16 mm

REF.: 10u/pack



Código: PEX008

Perno excéntrico TS 12.9.
17mm

REF.: 10u/pack



Código: FRE001

Fresa BURS 1/4 MD
10x20mm

REF.: 1u/pack



Código: LDA001

Laina de alineación delgada.
1/36.

REF.: 100u/pack

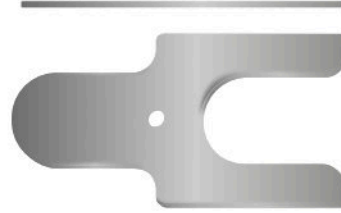

Código: LDA002

Laina de alineación mediana.
1/16.

REF.: 100u/pack



Código: LDA003

Laina de alineación gruesa.
1/8.

REF.: 100u/pack



Código: LDA011

Laina de alineación delgada.
1/36.

REF.: 100u/pack



Código: LDA012

Laina de alineación mediana.
1/16.

REF.: 100u/pack



Código: LDA013

Laina de alineación gruesa.
1/8.

REF.: 100u/pack



Código: HEN025

Nivel de camber 2 piezas.
camber con base ajustable.

REF.: 2u/pack



Código: HEN046

Nivel de camber 1 pieza.

REF.: 1u/pack



Código: HEN045

Seguro de volantes para alinear
bloquea el volante del auto.

REF.: 1u/pack



Código: HEN027

Seguro de volantes para alinear
bloquea el volante del auto.

REF.: 1u/pack



Código:MDA002

Medidor de aros plasticos
regla para medir aros

REF.: 1u/pack



Código: HEN010

Platos de alineación
41 x 34 x 6cm

REF.: 2u/pack



Código: CPD001

Calibrador digital 6"

REF.: 1u/pack



Código: CPD002

Calibrador Manual BP 6"

REF.: 1u/pack



Código: REP007

Cabeza de enlantadora 28mm

REF.: 1u/pack



Código: REP008

Cabeza de enlantadora 29mm

REF.: 1u/pack

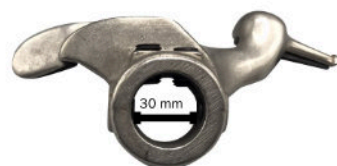

Código: REP009

Cabeza de enlantadora 30mm

REF.: 1u/pack



Código: REP004

Mariposa para maquinas
de balancear 36mm.

REF.: 1u/pack



Código: REP005

Mariposa para maquinas
de balancear 38mm.

REF.: 1u/pack



Código: REP006

Mariposa para maquinas
de balancear 40mm.

REF.: 1u/pack



Código: REP021

Repuesto de cabeza
de enlantadora

REF.: 1u/pack



Código: REP020

Repuesto de cabeza
de enlantadora

REF.: 1u/pack



ESPACIADORES

Para camioneta



Código: ESP001

6 huecos 139.7mm

A 6 huecos 139.7

Código: ESP003

6 huecos 135,7mm

A 6 huecos 127 mm

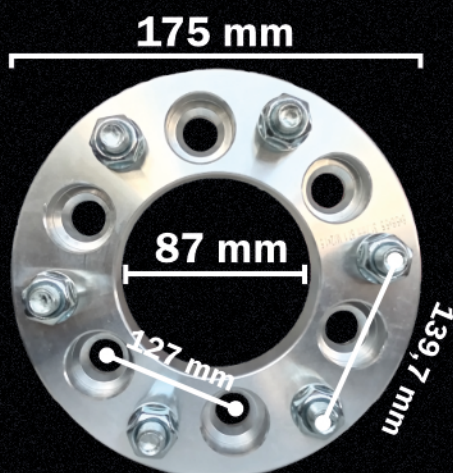
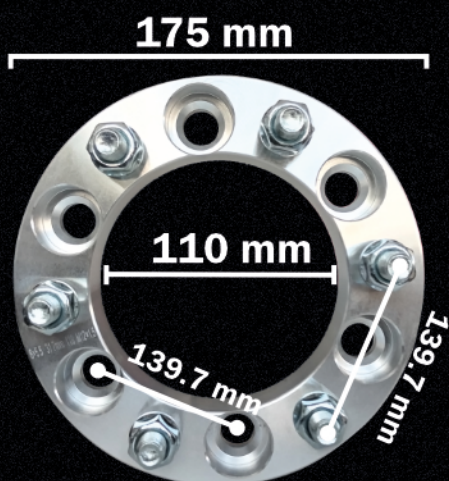



HEN041

PISTOLAS DE IMPACTO



**Chicago
Pneumatic**



HEN042

TUERCAS Y PERNOS



www.lavalvula.com.ec
@lavalvulaec



Dirección: Calderón, calle Sicilia OE5-47 entre Derby y Nápoles

Telefonos: 098 664 2817 - 02 282 6285

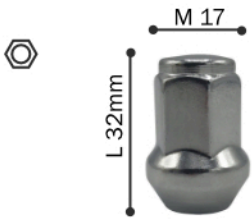

Código: TNL011

Tuerca normal mando 17.
Medida: 10x1,25 L32mm

REF: 50u/pack

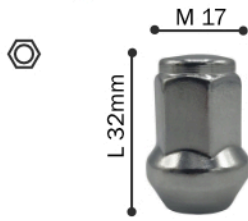

Código: TNL013

Tuerca normal mando17.
Medida: 12x1,50 L32mm.

REF: 50u/pack

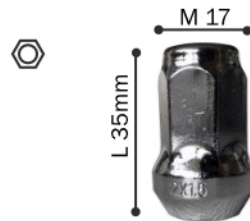

Código: TNL017

Tuerca normal mando17.
Medida: 12x1,50 L35mm.

REF: 50u/pack

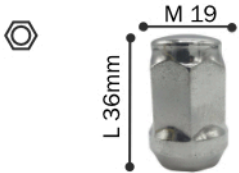

Código: TNL002

Tuerca normal mando19.
Medida: 12x1,25 L 36mm.

REF: 50u/pack

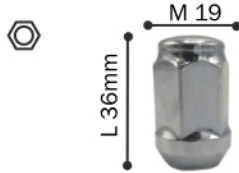

Código: TNL005

Tuerca normal mando19.
Medida: 12x1,50 L 36mm.

REF: 50u/pack

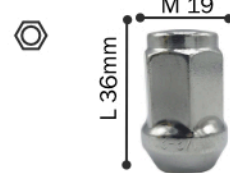

Código: TNL020

Tuerca normal mando 19.
Medida: 1/2 x 20 L 36mm.

REF: 50u/pack

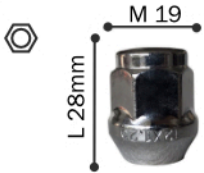

Código: TNL035

Tuerca normal mando 19.
Medida: 12x1,25 L 28mm.

REF: 50u/pack

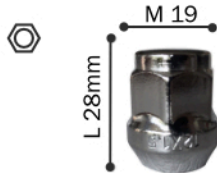

Código: TNL036

Tuerca normal mando 19.
Medida: 12x1,50 L 28mm.

REF: 50u/pack



Código: TNL003

Tuerca normal mando21.
Medida: 12x1,25 L 28mm.

REF: 50u/pack



Código: TNL006

Tuerca normal mando 21.
Medida: 12 x 1,50 L 36mm.

REF: 50u/pack



Código: TNL004

Tuerca normal mando 21.
Medida: 12x1,25 L 35mm.

REF: 50u/pack



Código: TNL010

Tuerca normal mando 21.
Medida: 12x1,50 L 35mm.

REF: 50u/pack

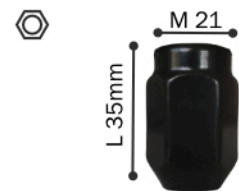

Código: TNL015

Tuerca normal mando 21.
Medida: 12x1,50 L 35mm.

REF: 50u/pack

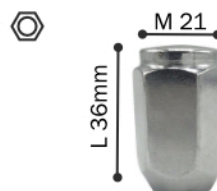

Código: TNL018

Tuerca normal mando 21.
Medida: 7/16 L 35mm.

REF: 50u/pack



Código: TNL019

Tuerca normal mando 21.
Medida: 12x1,75 L 35mm.

REF: 50u/pack



Código: TNL030

Tuerca de aluminio normal roja.
Medida: 12x1,50.

REF: 20u/pack



Código: TNL028

Tuerca de aluminio normal azul
Medida: 12x1,50.

REF: 20u/pack



Código: TNL029

Tuerca de aluminio normal
amarillo. Medida: 12x1,50.

REF: 20u/pack

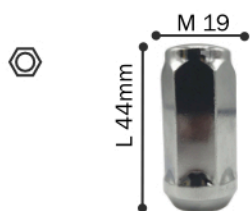
**Código: TNL021**

Tuerca normal mando 19.
Medida: 14x1,50 L 44mm.

REF.: 50u/pack

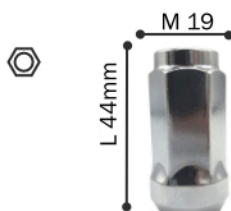
**Código: TNL012**

Tuerca normal mando 19.
Medida: 14x2 L 44mm.

REF.: 50u/pack

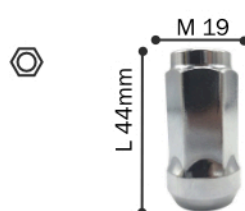
**Código: TNL027**

Tuerca normal mando 19.
Medida: 9/16 L 44mm.

REF.: 50u/pack

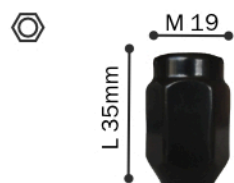
**Código: TNL014**

Tuerca normal mando 19.
Medida: 12x1,50 L 35mm.

REF.: 50u/pack

**Código: TNL031**

Tuerca normal Toyota mando 21.
Medida: 12x1,25 L 36mm.

REF.: 25u/pack

**Código: TNL025**

Tuerca normal TOYOTA mando 21.
Medida: 12x1,50 L 41mm.

REF.: 30u/pack

**Código: TNL034**

Tuerca normal Toyota mando 21.
Medida: 14x1,50 L 47mm.

REF.: 50u/pack

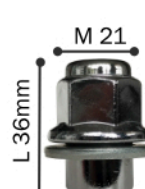
**Código: TNL037**

Tuerca normal Toyota mando 21.
Medida: 12x1,50 L 36mm.

REF.: 25u/pack

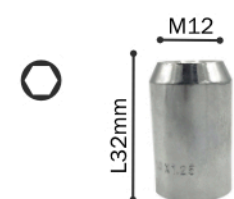
**Código: TEC001**

Tuerca especial cromada.
Medida: 10x1,25.

REF.: 50u/pack

**Código: TEC002**

Tuerca especial cromada.
Medida: 12x 1,25.

REF.: 50u/pack

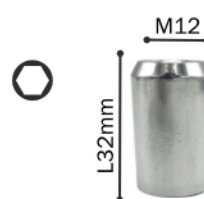
**Código: TEC003**

Tuerca especial cromada.
Medida: 12x1,50.

REF.: 50u/pack

**Código: TEC004**

Tuerca especial cromada.
Medida: 14x1,50.

REF.: 50u/pack

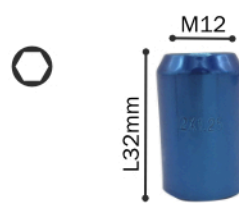
**Código: TEC005**

Tuerca especial cromada azul.
Medida: 12x 1,25.

REF.: 50u/pack

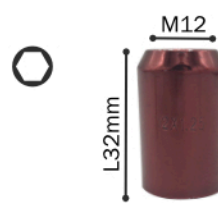
**Código: TEC007**

Tuerca especial cromada roja.
Medida: 12x1,50.

REF.: 50u/pack

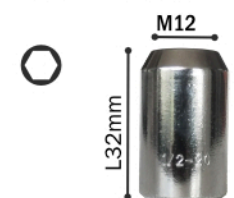
**Código: TEC010**

Tuerca especial cromada.
Medida: 1/2x20 L 35mm.

REF.: 50u/pack

**Código: TEC011**

Tuerca especial negra.
Medida: 12x1,50 L 35mm.

REF.: 50u/pack



Código: TSG001

Kit tuerca de seguridad.
Medida: 12x1,25.

REF.: 4u/pack + 1 llave



Código: TSG002

Kit tuerca de seguridad.
Medida: 12x 1,50.

REF.: 4u/pack + 1 llave



Código: TSG003

Kit tuerca de seguridad.
Medida: 14x1,50.

REF.: 4u/pack + 1 llave



Código: TSG004

Kit tuerca de seguridad.
Medida: 10x1,25.

REF.: 4u/pack + 1 llave



Código: TSG005

Kit tuerca de seguridad.
Medida: 14x2 L44mm.

REF.: 4u/pack + 1 llave



Código: TSG006

Kit tuerca de seguridad.
Medida: 12x1,25.

REF.: 4u/pack + 2 llave



Código: TSG008

Kit tuerca de seguridad.
Medida: 12x1,50.

REF.: 4u/pack + 2 llave



Código: TSG009

Kit tuerca de seguridad.
Medida: 12x 1,25.

REF.: 4u/pack + 1 llave



Código: TSG010

Kit tuerca de seguridad.
Medida: 14x2.

REF.: 4u/pack + 1 llave



Código: TSG011

Kit tuerca de seguridad.
Medida: 12x1,50 L 44mm.

REF.: 4u/pack + 1 llave



Código: TSG012

Kit tuerca de seguridad.
Medida: 12x1,25 L 44mm.

REF.: 4u/pack + 1 llave



Código: TSG013

Kit tuerca de seguridad.
Medida: 1/2 - 20.

REF.: 4u/pack + 1 llave

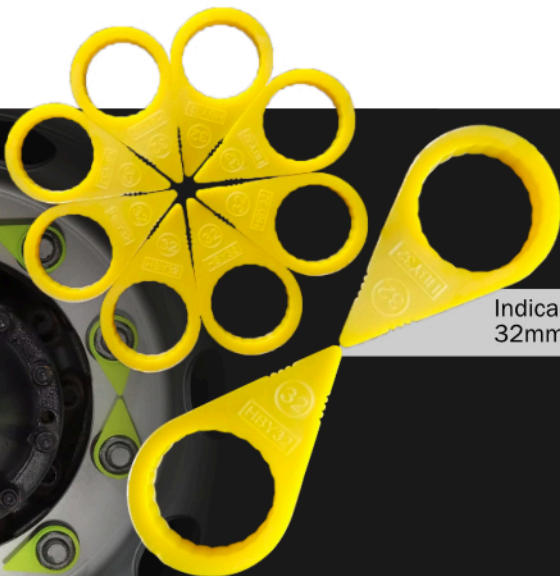

Código: TNL050

Indicador de tuerca suelta
32mm.



Código: PNL001

Perno normal mando 17.
Medida: 12x1,25.

REF.: 50u/pack



Código: PNL003

Perno normal mando 17.
Medida: 12x 1,50.

REF.: 50u/pack



Código: PNL004

Perno normal mando 17.
Medida: 14x1,50.

REF.: 50u/pack



Código: PEC001

Perno especial cromado.
Medida: 12x1,25.

REF.: 50u/pack.



Código: PEC002

Perno especial cromado.
Medida: 12x1,50.

REF.: 50u/pack.



Código: PEC003

Perno especial cromado.
Medida: 14x1,50.

REF.: 50u/pack.



Código: PEC004

Perno especial cromado
Medida: 14x1,50.

REF.: 50u/pack



Código: PSG001

Kit perno de seguridad.
Medida: 12x1,25.

REF.: 4u/pack + 1 llave



Código: PSG002

Kit perno de seguridad.
Medida: 12x1,50.

REF.: 4u/pack + 1 llave



Código: PSG003

Kit perno de seguridad.
Medida: 14x1,50.

REF.: 4u/pack + 1 llave



Código: PSG004

Kit perno de seguridad.
Medida: 12x 1,25

REF.: 4u/pack + 1 llave



Código: LLH001

Llave hexagonal negra.

REF.: 1u/pack



Código: LLH002

Llave hexagonal plateada.

REF.: 1u/pack



Código: LLH003

Llave hexagonal cromada.

REF.: 1u/pack



Código: LLH006

Llave hexagonal reforzada.

REF.: 1u/pack



Código: LLH004

Adaptador para tuerca.

REF.: 1u/pack

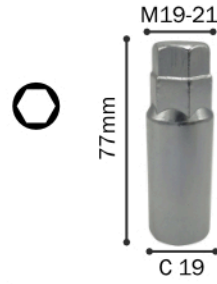

Código: LLH005

Adaptador para tuerca.
Copa 19 / M 19 - 21

REF.: 1u/pack



Código: LLH008

Adaptador de tuerca.
L64 copa 21 / M 19-21.

REF.: 1u/pack



Código: LLH007

Llave hexagonal de impacto.
GR-MO H12.

REF.: 1u/pack



Código: LLH011

Adaptador de tuerca.
M 17 para llave 19/21

REF.: 1u/pack



Código: ESP002

Separador 3mm.
Huecos 4-5 / 98 - 120mm.

REF.: 4u/pack



Código: ESP004

Separador 6mm.
Huecos 5-6 / 130 - 139,7mm.

REF.: 4u/pack



Código: ESP005

Separador 5mm.
Huecos 4-5 / 98-120mm.

REF.: 4u/pack



Código: ESP006

Separador 6mm.
Huecos 4-5 / 98-120mm.

REF.: 4u/pack



Código: ESP008

Separador 8mm.
Huecos 4-5 / 98-120mm.

REF.: 4u/pack

Código: ESP001

Separador 317 mm.
Huecos 6 / 139,7-139,7mm

REF: 2u/pack

Código: ESP003

Separador 317 mm.
Huecos 6 / 127-139,7mm

REF: 2u/pack

Código: ESP009

Separador 1.50".
Huecos 6 / 139,7-135,7mm

REF: 2u/pack

Código: ESP010

Separador 2.0".
Huecos 6 / 139,7 - 135,7mm

REF: 2u/pack

Código: CEN001

Centrador plástico.
Medida: de 73.1 a 56.6.

REF: 1u/pack

Código: CEN002

Centrador plástico.
Medida: de 73.1 a 67.1.

REF: 1u/pack

Código: CEN003

Centrador plástico.
Medida: de 67.1 a 56.6.

REF: 1u/pack

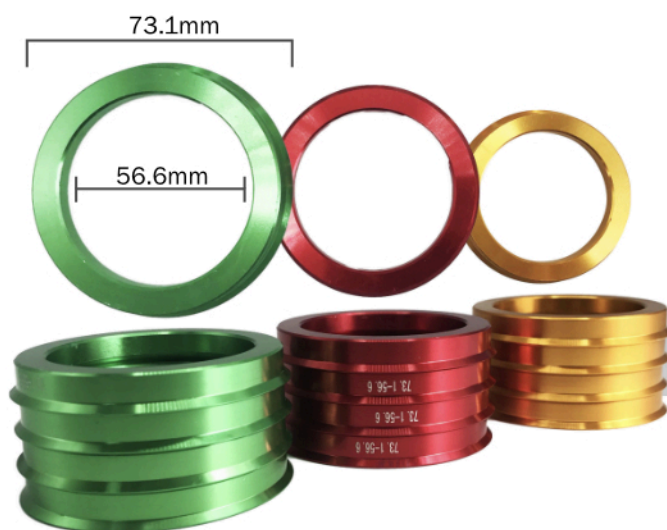
Código: CEN004

Centrador aluminio de colores.
Medida: de 73.1 a 66.6.

REF: 1u/pack

Código: MDA001

Medidor de distancia de huecos.

REF: 1u/pack.

LA MEJOR CALIDAD

Ø12
Base

90°
Grados

100%

Código: VMT008

Válvula PVR50.
Ø12 x 34 mm X 90°.
REF.: 10u/pack

SCOOTERS

ÁREA



Código: PVI043

Parche flexible R00.
Ø 3mm.

REF.: 100u/pack

Parche universal flexible Vipal de 3 mm de diámetro. Perfecto para reparar pequeños daños en las llantas



www.lavalvula.com.ec
@lavalvulaec





S-568

MEDIDOR DE AIRE

PRECISIÓN EXTREMA $\pm 0.05\%$

EMPUÑADURA ERGONÓMICA

MANOMETRO DIGITAL

MILTON



580e

MEDIDOR DE AIRE



PRECISIÓN EXTREMA $\pm 0.05\%$

EMPUÑADURA ERGONÓMICA

PANTALLA DIGITAL CON ROTOSCOPIO

MILTON



www.lavalvula.com.ec

@lavalvulaec



Dirección: Calderón, calle Sicilia OE5-47 entre Derby y Nápoles

Telefonos: 098 664 2817 - 02 282 6285



Conección Hembra

Conección Macho



Código: ACP001

Acople rápido 715.
Conección: 1/4" FNPT.

REF.: 1u/pack



Código: ACP002

Acople rápido 716.
Conección: 1/4" FNPT.

REF.: 1u/pack



Código: CNT001

Conector Milton 727.
Conección: 1/4" MNTP.

REF.: 1u/pack



Código: ACP010

Acople rápido S-99705.
Conección: 1/4" FNPT.

REF.: 1u/pack



Código: ACP016

Acople rápido 1750.
Conección: 1/4" FNPT.

REF.: 1u/pack



Código: CNT002

Conector Milton 728.
Conección: 1/4" MNTP.

REF.: 1u/pack



Código: ACP017

Acople rápido 1803.
Conección: 1/4" - 3/8" FNPT.

REF.: 1u/pack



Código: ACP015

Acople rápido 1804.
Medida: 1/4" - 3/8" MNTP

REF.: 1u/pack



Código: CNT009

Conector Milton 1809.
Medida: 1/4" - 3/8" MNTP.

REF.: 1u/pack

 **Conección Hembra**



Código: ACP008

Acople rápido 1835.
Conexión: 3/8" - 3/8" FNPT.

REF.: 1u/pack

 **Conección Macho**



Código: CNT004

Conector Milton 1837.
Medida: 3/8" - 3/8" MNPT.

REF.: 1u/pack



ESTILO "H" FLUJO DE AIRE 3/8"



Código: ACP005

Acople rápido 1815.
Medida: 1/2" - 1/2" FNPT.

REF.: 1u/pack



Código: ACP006

Conector Milton 1817.
Medida: 1/2" - 1/2" MNPT.

REF.: 1u/pack

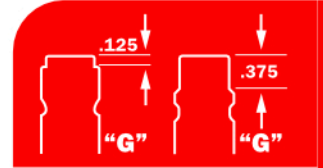

ESTILO "G" FLUJO DE AIRE 1/2"



Código: RED001

Reductor Milton 650.
Medida: 1/4" a 1/8".

REF.: 1u/pack



Código: RED003

Reductor Milton 651.
Medida: 3/8" a 1/4".

REF.: 1u/pack



Código: RED004

Reductor Milton 651-1.
Medida: 1/2" a 1/4".

REF.: 1u/pack

REDUCTORES



Código: RED005

Reductor Milton 652.
Medida: 1/2" a 3/8".

REF.: 1u/pack



Código: RED006

Reductor Milton 652-1.
Medida: 3/4" a 1/4"

REF.: 1u/pack



Código: RED007

Reductor Milton 652-4.
Medida: 3/4" a 3/8"

REF.: 1u/pack



Código: RED008

Reductor Milton 652-8.
Medida: 3/4" a 1/2".

REF.: 1u/pack



Código: CNT011

Conector 601.
Medida: 5/16" - 1/4".

REF.: 1u/pack

Código: INF002

Inflador Milton S-690
cabeza curva.

REF.: 1u/pack

Código:INF003

Inflador milton 693
Cbeza recta.

REF.: 1u/pack

Código: INF008

Repuesto cabeza curva 500-4
para inflador o medidor.

REF.: 1u/pack

Código: INF001

Inflador Milton con manometro .
Modelo S-506.
Rango de presión : 0-106Psi.

REF.: 1u/pack

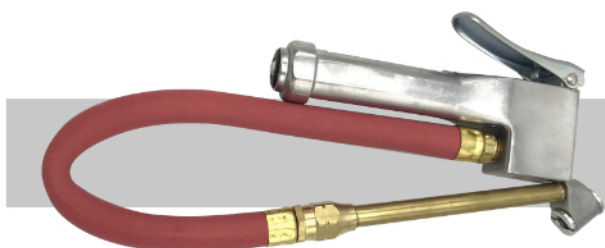
Código: INF0011

Inflador Milton estilo bayoneta.
Modelo S-520.
Rango de presión : 0-122Psi.

REF.: 1u/pack

Código: INF015

Inflador Milton manometro digital.
Modelo S-568.
Rango de presión : 0-255Psi.

REF.: 1u/pack

Código: INF014

Inflador Milton digital.
Modelo 580e.
Rango de presión : 0-1100Psi.

REF.: 1u/pack



Código: MED002

Medidor de aire Milton S-976
cabeza curva dual.
10-160 Psi / 80-1100Kpa.
REF.: 1u/pack



Código: MED003

Medidor de aire Milton S-986
cabeza recta dual.
10-160 Psi / 80-1100Kpa.
REF.: 1u/pack



Código: MED001

Medidor de aire Milton S-927
cabeza curva dual.
20-120 Psi / 120-820Kpa.
REF.: 1u/pack



Código: MED011

Medidor de aire Milton S-928
5-50 Psi / 40-350Kpa.
REF.: 1u/pack



Código: MED012

Medidor de aire Milton S-976C
cabeza curva dual.
10-160 Psi / 80-1100Kpa.
REF.: 1u/pack



Código: MED013

Medidor de aire Milton S-982
cabeza recta dual.
10-160 Psi / 80-1100Kpa.
REF.: 1u/pack



Código: PUL001

Pulverizador Milton S-156
14" Npt. - 14.0 Scfm.
REF.: 1u/pack



Código: EMP002

Empaque acople rapido.
REF.: 50u/pack



Código: EMP005

Empaque inflador y medidor.
REF.: 50u/pack



Código: PUL003

Pulverizador Milton S-148
14" Npt. - 14.0 Scfm.
REF.: 1u/pack



Conexión Macho



Conexión Push-on



Conexión con Lengüeta

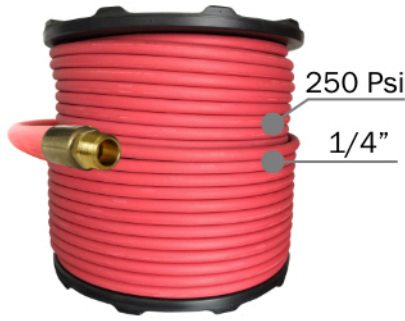

Código: MAN014

Manguera Milton 250Psi
Medida: 1/4" x metros.

REF.: 1u/pack



Código: CNT030

Abrazadera 1654-5.
Medida: 5/8"

REF.: 1u/pack



Código: CNT010

Conector Milton 600.
Medida: 1/4" - 1/4".

REF.: 1u/pack



Código: ACP001

Acople rápido 715.
Conexión: 1/4" FNPT.

REF.: 1u/pack



Código: ACP016

Acople rápido 1750.
Conexión: 1/4" FNPT.

REF.: 1u/pack



Código: CNT002

Conector Milton 728.
Conexión: 1/4" MNTP.

REF.: 1u/pack



Código: CNT006

Conector Milton 736.
Medida: 1/4"-1/4".

REF.: 1u/pack



Código: ACP014

Acople rápido 1717-4 estilo "M".
Medida: 1/4" - 1/4"

REF.: 1u/pack



Código: ACP011

Acople rápido 717 estilo "M".
Medida: 1/4" - 1/4"

REF.: 1u/pack



Conexión Macho



Conexión Push-on



Conexión con Lengüeta

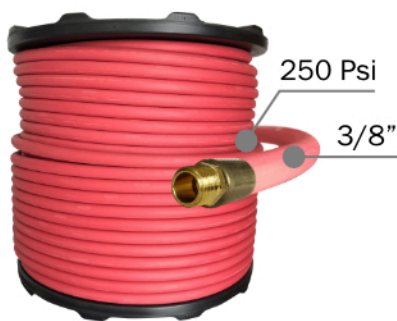

Código: MAN015

Manguera Milton 250Psi

Medida: 3/8" x metros.

REF.: 1u/pack



Código: CNT031

Abrazadera 1654-8.

Medida: 23/32"

REF.: 1u/pack



Código: CNT012

Conector 602.

Medida: 1/4" 3/8".

REF.: 1u/pack



Código: ACP017

Acople rápido 1803.

Conexión: 1/4" - 3/8" FNPT.

REF.: 1u/pack



Código: CNT008

Conector milton 1736-6.

Medida: 3/8" - 1/4".

REF.: 1u/pack



Código: CNT007

Conector Milton 736-6.

Medida: 3/8"-3/8".

REF.: 1u/pack



Código: ACP013

Acople rápido 1717-6.

Medida: 3/8" -1/4".

REF.: 1u/pack



Código: ACP012

Acople rápido 717-6.

Medida: 3/8" - 1/4"

REF.: 1u/pack



Código: ACP001

Acople rápido 715.

Conexión: 1/4" - 1/4" FNPT.

REF.: 1u/pack



Conección Macho



Conección Push-on



Conección Hembra

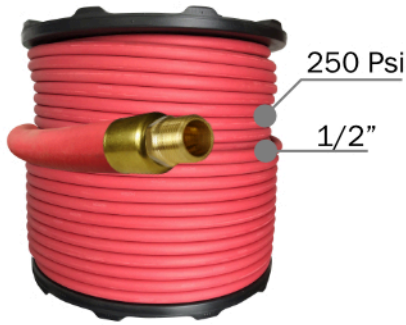

Código: MAN016

Manguera Milton 250Psi
Medida: 1/2" x metros.
REF.: 1u/pack



Código: CNT032

Abrazadera 1654-12.
Medida: 7/8".
REF.: 1u/pack



Código: CNT005

Conector Milton 604-1.
Medida: 1/2" - 1/2".
REF.: 1u/pack



Código: CNT013

Conector 604.
Medida: 1/2" - 3/8".
REF.: 1u/pack



Código: ACP005

Acople rápido 1815.
Medida: 1/2" - 1/2" FNPT.
REF.: 1u/pack



Código: ACP006

Conector Milton 1817.
Medida: 1/2" - 1/2" MNPT.
REF.: 1u/pack



Código: CNT013

Union hembra.
Medida: 1/2" - 1/2".
REF.: 1u/pack



Código: CNT013

Union hembra.
Medida: 1/2" - 1/2".
REF.: 1u/pack

ACEITE PARA HERRAMIENTAS NEUMÁTICAS

OIL009



OIL011



OIL010



OIL012



OIL013





BUFFALO

KIT DADOS DE IMPACTO



CÓDIGO:

DAD010

INCLUYE:

DADO 17, 21, 24, 27

30, 32, 33, 34, 36 Y 41mm

PISTOLAS Y DADOS DE IMPACTO



www.lavalvula.com.ec

@lavalvulaec



Dirección: Calderón, calle Sicilia OE5-47 entre Derby y Nápoles

Telefonos: 098 664 2817 - 02 282 6285

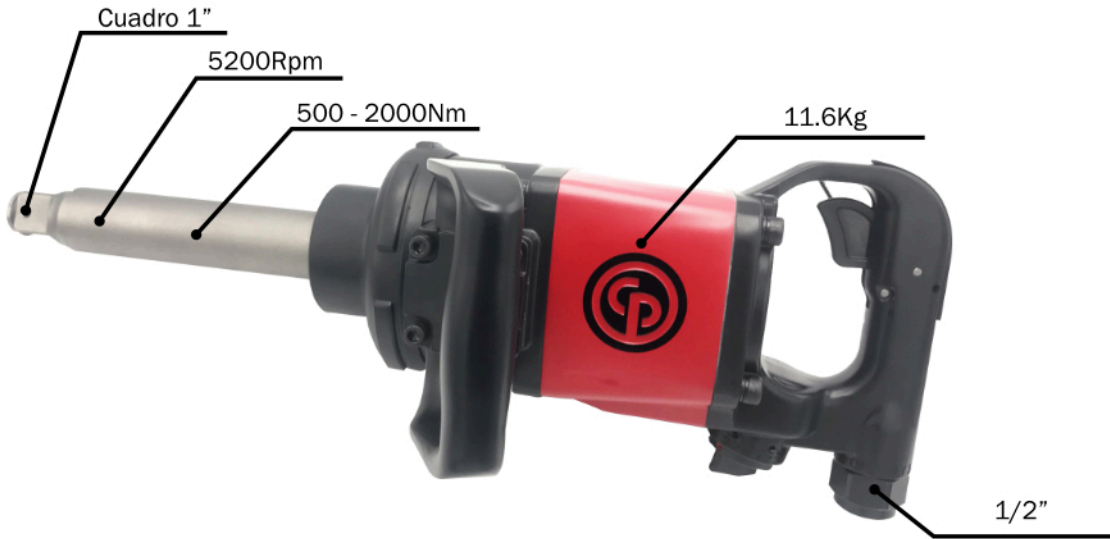

Código: HEN042

Pistola de impacto CHICAGO PNEUMATIC CP7782-6.
Cuadro de 1" / 5200Rpm / Torque 500-2000Nm.
REF.: 1u/pack

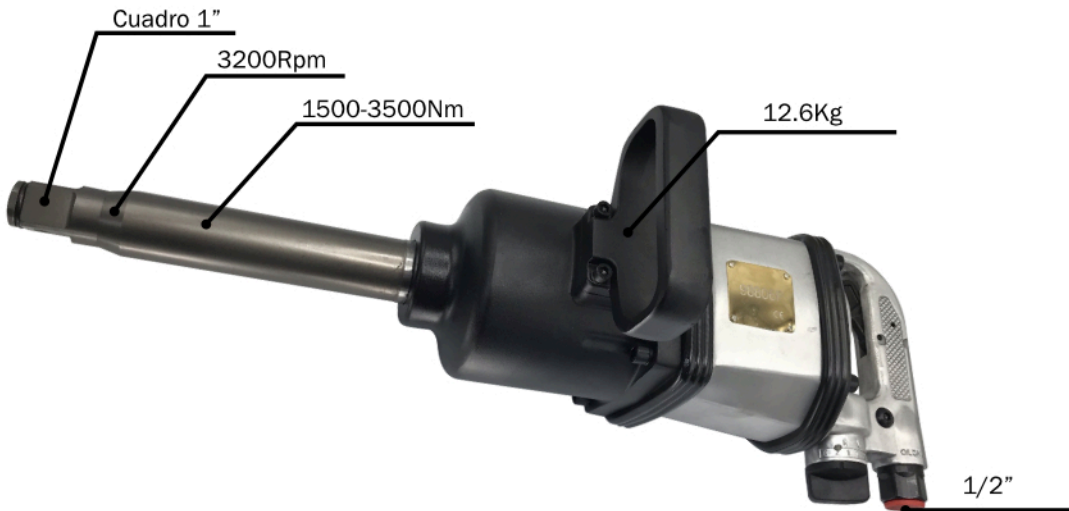

Código: HEN047

Pistola de impacto BUFFALO.
Cuadro de 1" / 3200Rpm / 1500-3500Nm.
REF.: 1u/pack



Código: HEN022

Pistola de impacto MARSHALL.
Cuadro de 1" / 3200Rpm / Torque 1500-3000Nm.
REF.: 1u/pack



Código: HEN041

Pistola de impacto CHICAGO PNEUMATIC
Cuadro de 1/2" / 10020Rpm / 69-770Nm.
REF.: 1u/pack



Código: HEN058

Pistola de impacto sin dados 12A01P-B.
Cuadro de 1/2" / 8000Rpm / 200-600Nm.
REF.: 1u/pack



Código: HEN003

Pistola de impacto sin dados MARSHALL
Cuadro de 1/2" / 8000Rpm / 200-600Nm.
REF.: 1u/pack



Código: HEN014

Pistola de impacto sin dados 12A01B2-B.
Cuadro de 3/4" / 6000Rpm / 1200Nm.
REF.: 1u/pack



Código: HEN050

Pistola de impacto MARSHALL.
Cuadro de 1/2" / 8500Rpm / 850Nm.
REF.: 1u/pack

| DADOS : 9mm | 22mm | Extensión |
|-------------|------|------------------|
| 10mm | 24mm | Conector de aire |
| 11mm | 27mm | Llave hexagonal |
| 13mm | | |
| 14mm | | |
| 17mm | | |
| 19mm | | |



Código:HEN002

Pistola de impacto BUFFALO
Cuadro de 1/2" / 7500Rpm / 660Nm.

REF.: 1u/pack

| | | |
|-------------|------|-------------------|
| DADOS : 9mm | 22mm | Extensión |
| 10mm | 24mm | Conector de aire |
| 11mm | 27mm | Aceite lubricante |
| 13mm | | |
| 14mm | | |
| 17mm | | |
| 19mm | | |



Código:HEN061

Ratchet neumático
Cuadro de 1/4" / 160Rpm / 68Nm.

REF.: 1u/pack



Código: OIL010

Aceite para herramientas
neumáticas 1001-32. 946ml.

REF.: 1u/pack



Código: OIL011

Aceite para herramientas
neumáticas 1001-16. 473ml.

REF.: 1u/pack



Código: OIL012

Aceite para herramientas
neumáticas 1001-4. 118ml.

REF.: 1u/pack



Código: OIL009

Aceite para compresor 1002-32.
946ml.

REF.: 1u/pack



Código: OIL013

Limpiador para herramientas
neumáticas 1003-4. 118ml

REF.: 1u/pack



Código: DAD004

Dado de impacto delgado.
Medida: 1/2x17mm.

REF.: 1u/pack



Código: DAD005

Dado de impacto delgado.
Medida: 1/2x19mm.

REF.: 1u/pack



Código: DAD006

Dado de impacto delgado.
Medida: 1/2x21mm.

REF.: 1u/pack



Código: DAD007

Dado de impacto delgado corto.
Medida: 1/2x22mm.

REF.: 1u/pack



Código: DAD012

Dado de impacto delgado corto.
Medida: 1/2x21mm.

REF.: 1u/pack

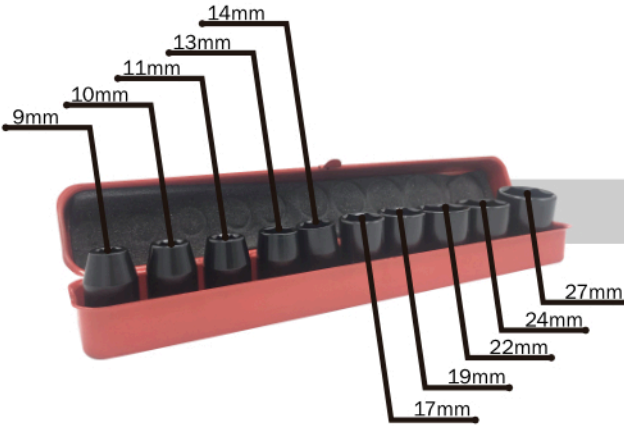

Código: DAD003

Set 10 dados de impacto con
estuche metálico.

REF.: 10Pcs/pack



Código: DAD0041

Dado cromado largo TopTul.
Medida: 1/2x17mm.

REF.: 1u/pack



Código: DAD0051

Dado cromado delgado TopTul.
Medida: 1/2x19mm.

REF.: 1u/pack



Código: DAD0062

Dado cromado delgado TopTul.
Medida: 1/2x21mm.

REF.: 1u/pack



Código: DAD0031

Set 3 dados de impacto 1/2 con estuche plastico.

REF.: 3Pcs/pack



Código: DAD0032

Set 3 dados de impacto 1/2 con estuche plastico.

REF.: 3Pcs/pack



Código: DAD0052

Dado de impacto delgado TopTul. Medida: 1/2x19mm.

REF.: 1u/pack



Código: DAD0061

Dado de impacto delgado TopTul. Medida: 1/2x21mm.

REF.: 1u/pack



Código: DAD006

Dado de impacto delgado TopTul. Medida: 1/2x22mm.

REF.: 1u/pack



Código: DAD016

Dado de impacto 1". Medida: 24mm

REF.: 1u/pack



Código: DAD018

Dado de impacto 1". Medida: 27mm

REF.: 1u/pack



Código: DAD027

Dado de impacto 1".
Medida: 28mm.
REF.: 1u/pack



Código: DAD020

Dado de impacto 1".
Medida: 30mm.
REF.: 1u/pack



Código: DAD002

Dado de impacto 1".
Medida: 32mm.
REF.: 1u/pack



Código: DAD001

Dado de impacto 1".
Medida: 33mm.
REF.: 1u/pack



Código: DAD025

Dado de impacto 1".
Medida: 34mm.
REF.: 1u/pack



Código: DAD019

Dado de impacto 1".
Medida: 35mm.
REF.: 1u/pack



Código: DAD021

Dado de impacto 1".
Medida: 36mm.
REF.: 1u/pack



Código: DAD017

Dado de impacto 1".
Medida: 38mm.
REF.: 1u/pack



Código: DAD014

Dado de impacto 1".
Medida: 41mm.
REF.: 1u/pack



Código: DAD023

Dado de impacto 1".
Medida: cuadro 17.
REF.: 1u/pack



Código: DAD022

Dado de impacto 1".
Medida: cuadro 19.
REF.: 1u/pack



Código: DAD015

Dado de impacto 1".
Medida: cuadro 21.
REF.: 1u/pack

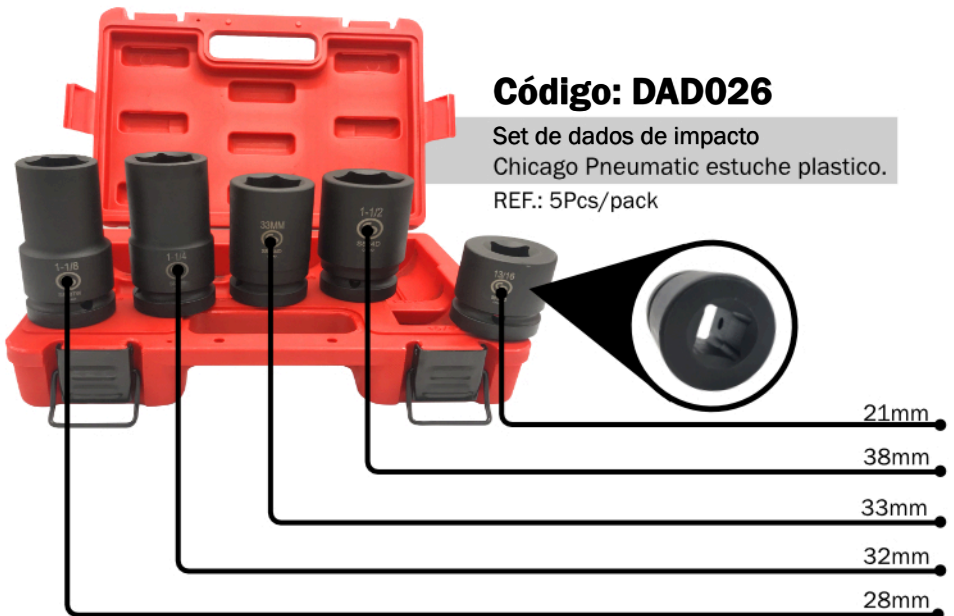

Código: DAD026

Set de dados de impacto
Chicago Pneumatic estuche plastico.
REF.: 5Pcs/pack



Código: DAD024

Reductor de impacto TopTul.
Medida: 1" a 3/4".

REF.: 1u/pack



Código: DAD0241

Reductor de impacto.
Medida: 3/4" a 1/2".

REF.: 1u/pack



Código: DAD0242

Reductor de impacto.
Medida: 3/4" a 1".

REF.: 1u/pack



Código: KT-0443519

Dado de impacto King Tony.
Medida: 19mm.

REF.: 1u/pack



Código: KT-441521M

Dado de impacto King Tony.
Medida: 21mm. pared delgada.

REF.: 1u/pack



Código: KT-443521

Dado de impacto King Tony.
Medida: 21mm.

REF.: 1u/pack



Código: KT-403508

Dado King Tony.
Punta: 1/2 x 8mm.

REF.: 1u/pack



Código: KT-403511

Dado King Tony.
Punta: 1/2 x 11mm.

REF.: 1u/pack



Código: KT-403614

Dado King Tony.
Punta: 1/2 x 14mm.

REF.: 1u/pack



Código: KT-403519

Dado King Tony.
Punta: 1/2 x 19mm.

REF.: 1u/pack



Código: HRM004

Multiplicador de fuerza
Dados: 33mm y 32mm.
Multiplicador de fuerza
REF.: 1u/pack

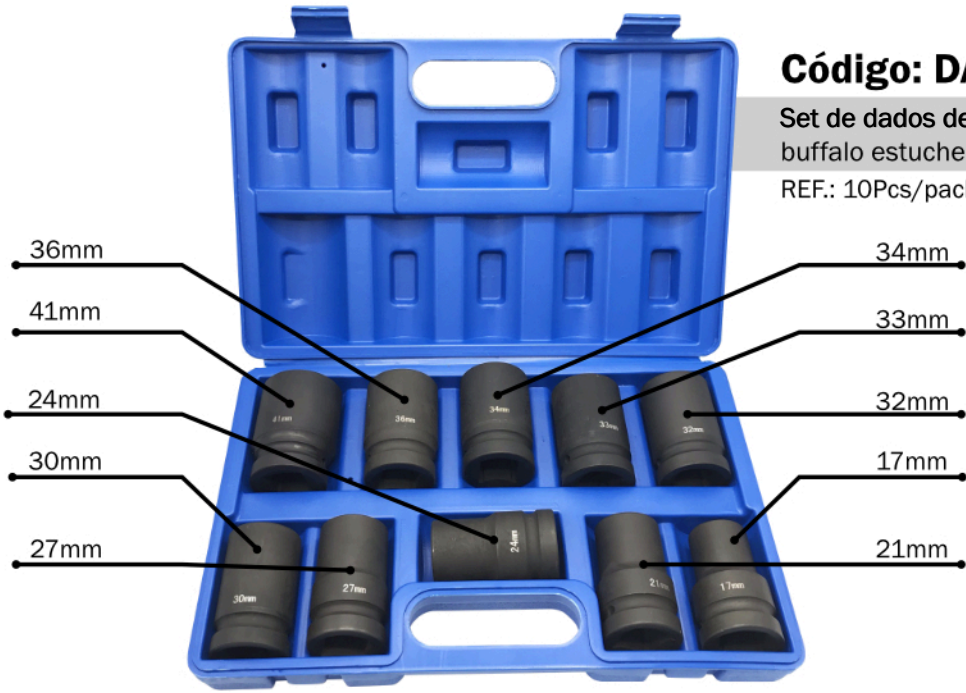

Código: DAD010

Set de dados de impacto
buffalo estuche plastico.

REF.: 10Pcs/pack



Código: HEN052

Filtro regulador y lubricador
buffalo de 1/4"

REF.: 1u/pack



Código: HEN053

Filtro regulador y lubricador
buffalo de 1/2"

REF.: 1u/pack



Código: HEN017

Filtro regulador y lubricador
buffalo de 1/4"

REF.: 1u/pack



BUFFALO

COLOR QUE INDICARA
FÁCILMENTE EL
ESTADO DE LA LLANTA

CÓDIGO:

MDP005

TAMAÑO COMPACTO DE 9cm

HERRAMIENTAS AIRE Y MEDICIÓN

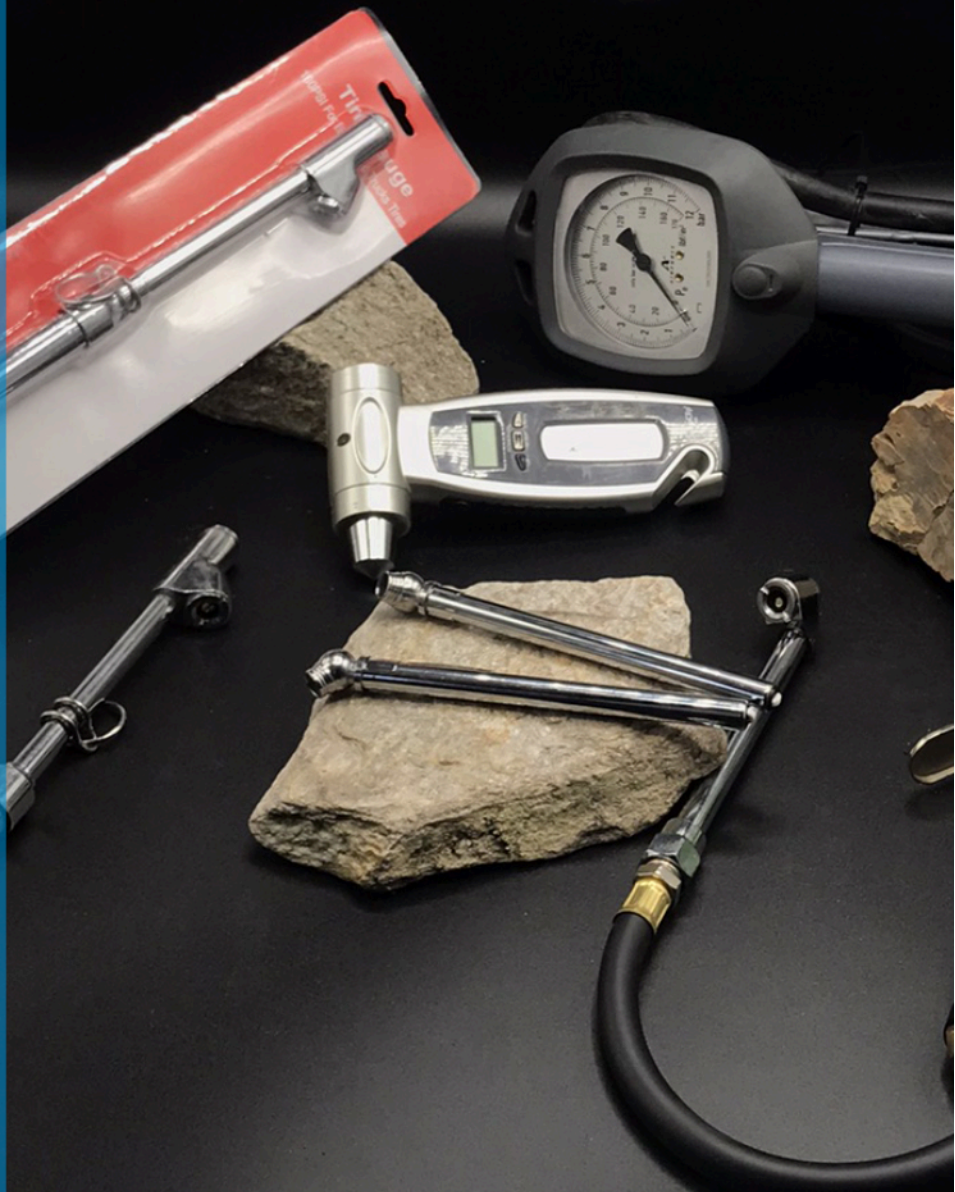

www.lavalvula.com.ec
[@lavalvulaec](https://www.instagram.com/lavalvulaec)



Dirección: Calderón, calle Sicilia OE5-47 entre Derby y Nápoles

Telefonos: 098 664 2817 - 02 282 6285



BUFFALO

BALANCEADORA



Código: HEN033

220v
Set de Conos
Martillo para Pesas

Mariposa
Medidor de Aro
Pesa de Calibración

Código: HEN064

Tanque recolector neumático de aceite 80LT

REF.: 1u/pack

Código: HEN063

Tanque recolector de aceite 80LT

REF.: 1u/pack

Código: 10015106

Aceitera manual elan tools

REF.: 1u/pack

Código: H421210B

Boquilla pistola de engrasar pequeña 3/8.

REF.: 1u/pack

Código: PE-001

Pistola de engrasador neumático

REF.: 1u/pack

HEN064
HEN063



Código: MPP007

Medidor de profundidad
tipo milton metálico
REF.: 1u/pack



Código: MDP002

Profesional rubber vulk.
Medidor de profundidad.
REF.: 1u/pack



Código: MDP003

Medidor de profundidad
metálico plano.
REF.: 1u/pack



Código: MDP004

Medidor de profundidad
digital DILL.
REF.: 1u/pack



Código: MDP005

Medidor de profundidad
con color Buffalo.
REF.: 1u/pack



Código: MDP006

Medidor de profundidad
para llantas OTR.
REF.: 1u/pack



Código: INF005

Inflador con manometro airforce
REF.: 1u/pack



Código: INF007

Inflador - medidor ECG019
REF.: 1u/pack



Código: INF012

Inflador - medidor verde
ECG-019.
REF.: 1u/pack



Código: INF010

Inflador - medidor digital
COSENG
REF.: 1u/pack



Código: INF013

Inflador - medidor bayoneta
ECG-028.
REF.: 1u/pack



Código: INF016

Inflador - medidor digital
Medida: 350mm.
REF.: 1u/pack



Código: INF009

Inflador negro cabeza recta
Medida: 350mm.
REF.: 1u/pack



Código: INC001

Inchador de aire AGRICOLA-OTR 8mm x 16mm

REF.: 1u/pack



Código: INC002

Inchador de aire 1/4" Para acople EAC - 007

REF.: 1u/pack



Código: INC003

Inchador de aire Para manguera 6mm x 16mm

REF.: 1u/pack



Código: INC004

Inchador de aire redondo con clip 8mm x 25mm

REF.: 1u/pack



Código: INC005

Inchador de aire Para manguera 8mm x 20mm

REF.: 1u/pack



Código: INC006

Inchador de aire Milton 1/4" FNTP 697-2.

REF.: 1u/pack



Código: KT-7990104

Pulverizador de aire King Tony 4"

REF.: 1u/pack



Código: PUL004

Pistola de aire Buffalo boquilla de 100 mm.

REF.: 1u/pack



Código: MED014

Medidor de aire pequeño 0-50 Psi

REF.: 1u/pack



Código: MED004

Medidor de aire cabeza curva barra metálica, 10-160 Psi

REF.: 1u/pack



Código: MED005

Medidor de aire cabeza recta barra metálica. 10-150 Psi

REF.: 1u/pack



Código: MED007

Medidor de aire digital TG002 2-99.5 Psi

REF.: 1u/pack



Código: MED010

Medidor de aire digital 4 en 1

REF.: 1u/pack



Código: MED006

Medidor de aire Rubber Vulk 10-150 Psi

REF.: 1u/pack



BUFFALO

HEN045



SOPORTE DE VOLANTE

**HERRAMIENTA PARA FIJAR
VOLANTES DURANTE LA
ALINEACIÓN**

PÁGINA 28



**Chicago
Pneumatic**

DAD026

**DADOS DE
IMPACTO**



PÁGINA 48



BUFFALO



MILTON

- Medidores de aire
- Acoples
- Conectores
- Infladores
- Lubricantes
- Reductores





LLAVES DE RUEDA



www.lavalvula.com.ec
[@lavalvulaec](https://www.instagram.com/lavalvulaec)



Dirección: Calderón, calle Sicilia OE5-47 entre Derby y Nápoles

Telefonos: 098 664 2817 - 02 282 6285

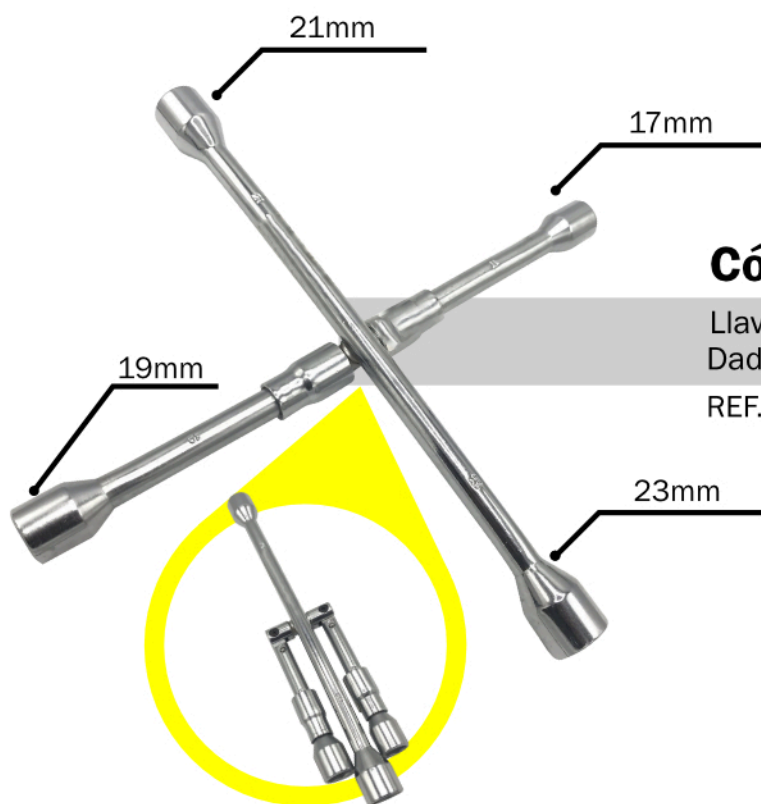
**Código: LLA002**

Llave de rueda desarmable.
Dados 17 - 19 - 21 - 23 mm.

REF.: 1u/pack

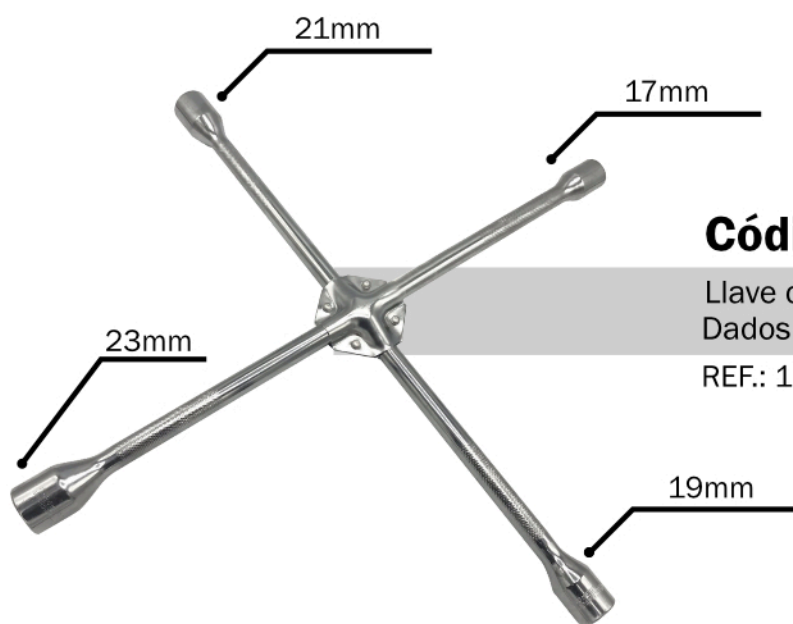
**Código: LLA003**

Llave de rueda 20" reforzada.
Dados 17 - 19 - 21 - 23 mm.

REF.: 1u/pack

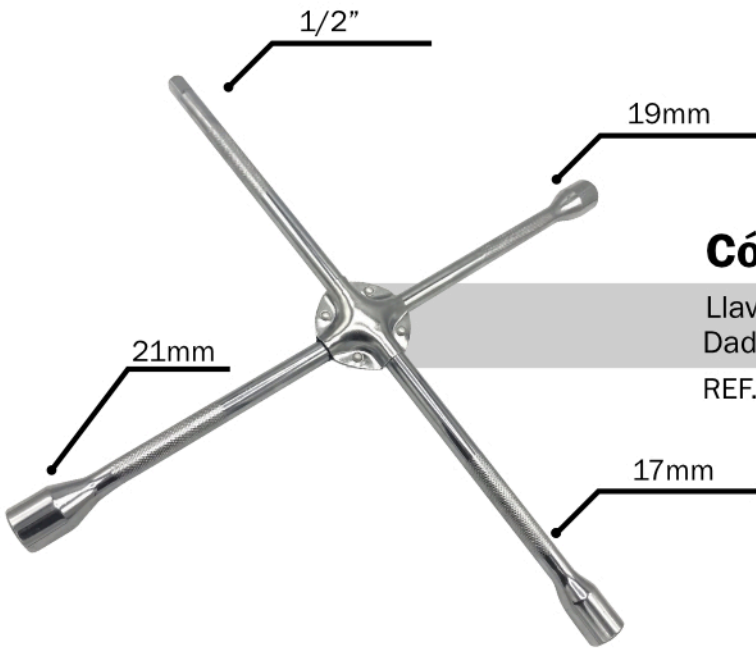

Código: LLA006

Llave de rueda para taller.
Dados 17 - 19 - 21 mm - 1/2".

REF.: 1u/pack



Código: LLA005

Kit llave de rueda tipo "L"
17x19mm - 21x23mm.

REF.: 1u/pack

Código: LLA004

Llave de rueda tipo "L"
 Dado 17mm.

REF.: 1u/pack



12,5cm

Código: HER008

Extensión de llave.
 1/2" x 12,5cm.

REF.: 1u/pack

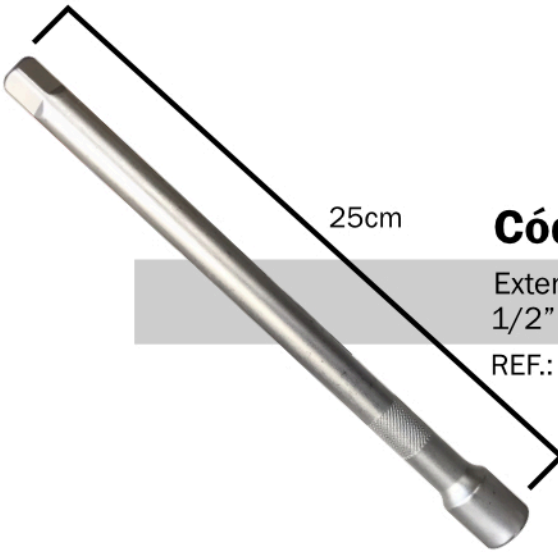

25cm

Código: HER009

Extensión de llave.
 1/2" x 25cm

REF.: 1u/pack

MANGUERAS



MANTIENE SU FLEXIBILIDAD INCLUSO A UNA TEMPERATURA DE -40°F

HASTA UN 50% MÁS LIGERA QUE LA GOMA
JUSQU'À 50% PLUS LÉGÈRE QUE LE CAOUTCHOUC

200
MAX PSI WP

-40°F

35 ft.
3/8 in.

GOBRA FLEX

PVC HÍBRIDO PRIMA
PVC HYBRIDE PREMIUM

MANGUERA DE AIRE
LE FLEXIBLE D'AIR

EXCEPCIONAL FLEXIBILIDAD PARA TODO TIPO DE CLIMA
PERMANECE FLEXIBLE A
-40°F to 140°F

LIGERO PERO RESISTENTE
RESISTE TORCEDURAS, PLANA
RACORES EN LATÓN MACIZO DE 1/4" NPT

SOUPLESE EXTREME EN TOUT TEMPS
RESTE SOUPLE JUSQU'À
-40°F to 140°F

LÉGÈRE ET POURTANT DURABLE
RÉSISTE À UN VRILLAGE, REPOSE À PLAT
RACCORDS EN LAITON MASSIF 1/4 PO NPT

LEVE GAFAS PROTECTORAS PORTEZ DES LUNETTES DE PROTECTION

2 AÑO DE GARANTÍA
2 AN DE GARANTIE

www.lavalvula.com.ec

@lavalvulaec



Dirección: Calderón, calle Sicilia OE5-47 entre Derby y Nápoles

Telefonos: 098 664 2817 - 02 282 6285

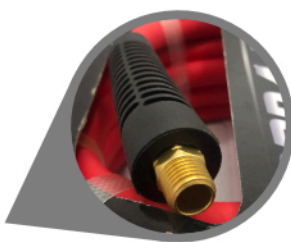

Código: MAN012

Manguera Milton Cobra Flex 300Psi
Medida: 3/8" x 10.67m.

REF.: 1u/pack

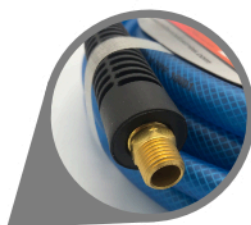

Código: MAN013

Manguera Milton Flex Hose 200Psi
Medida: 3/8" x 7.6m.

REF.: 1u/pack

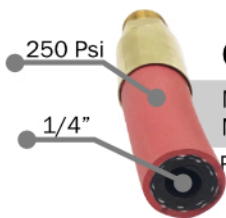

Código: MAN014

Manguera Milton 250Psi
Medida: 1/4" x metros.

REF.: 1u/pack

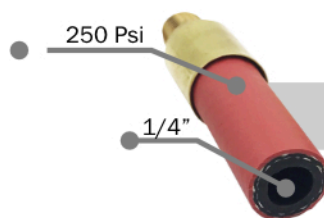

Código: MAN015

Manguera Milton 250Psi
Medida: 3/8" x metros.

REF.: 1u/pack

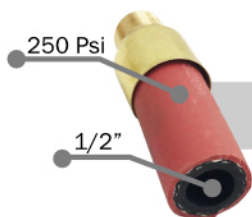

Código: MAN016

Manguera Milton 250Psi
Medida: 1/2" x metros.

REF.: 1u/pack



Código: MAN009

Manguera Milton 200Psi
Medida: 3/8" x 15.24m.

REF.: 1u/pack



Código: MAN010

Manguera Milton 200Psi
Medida: 1/4" x 7.62m.

REF.: 1u/pack



Código: MAN011

Manguera Amflo 200Psi
Medida: 1/4" x 7.62m.

REF.: 1u/pack



Código: MAN008

Manguera Buffalo 200Psi
Medida: 3/8" x 15m.

REF.: 1u/pack



Código: MAN017

Manguera de riel auto retractil.
300Psi.
Medida: 1/2" x 15,25m.

REF.: 1u/pack



Código: MAN018

Manguera de riel auto retractil.
300Psi.
Medida: 3/8" x 15,25m.

REF.: 1u/pack



Código: MAN030

Repuesto tope para manguera
1/2"

REF.: 1u/pack



Código: MAN031

Repuesto tope para manguera
3/8"

REF.: 1u/pack

PALANCAS DE MONTAJE Y DESMONTAJE



www.lavalvula.com.ec

@lavalvulaec



Dirección: Calderón, calle Sicilia OE5-47 entre Derby y Nápoles

Telefonos: 098 664 2817 - 02 282 6285

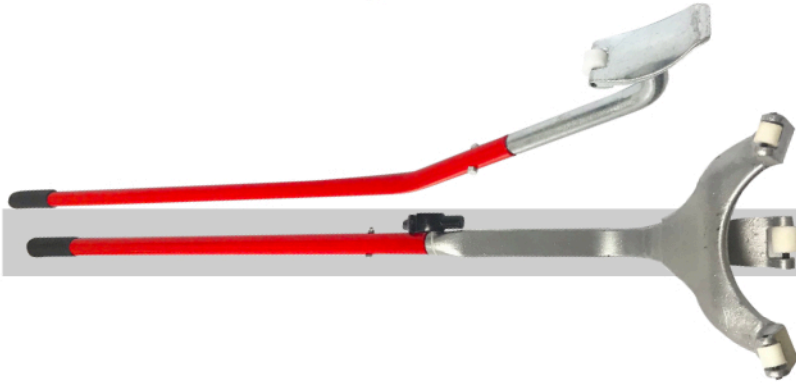

Código: HRM011

Set de palancas TNT
montado - desmontado.

REF.: 2u/pack

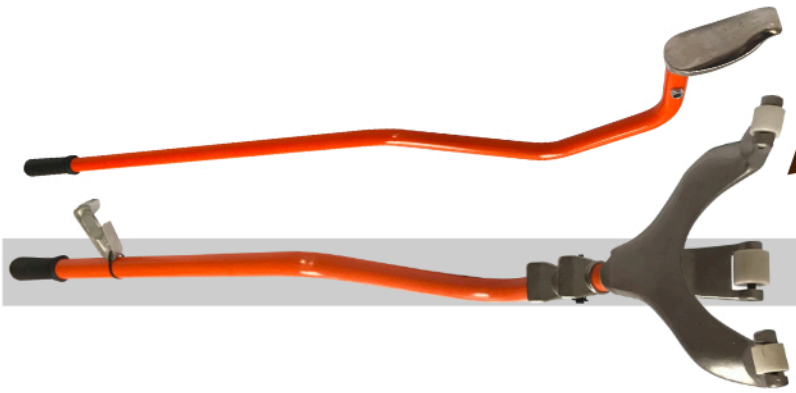

Código: HRM021

Set de palancas TNT
montado - desmontado.

REF.: 2u/pack



Código: HRM018

Set de 3 palancas
montado - desmontado.

REF.: 3u/pack



Código: HRM019

Set de 2 palancas
montado - desmontado.

REF.:2u/pack

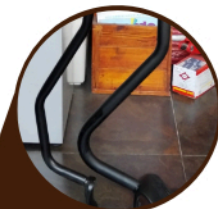

Código: HRM025

Set de 2 palancas
montado - desmontado.

REF.:2u/pack



Código: LUKATEC

Set de 2 palancas
montado - desmontado.

REF.:2u/pack





Código: HER013

Palanca continental KenTool.
Medida: 82cm.

REF.: 1u/pack



Código: HER014

Palanca continental KenTool.
Medida: 40cm.

REF.: 1u/pack



Código: HER018

Palanca continental KenTool.
Medida: 93cm.

REF.: 1u/pack



Código: HER001

Palanca continental TOPTUL.
Medida: 21" / 54cm.

REF.: 1u/pack



Código: HER010

Palanca continental.
Medida: 20" / 51cm.

REF.: 1u/pack



Código: HER011

Palanca continental.
Medida: 16" / 40,6cm.

REF.: 1u/pack



Código: HER017

Palanca continental.
Medida: 28" / 72cm.

REF.: 1u/pack



Código: HER021

Palanca continental.
Medida: 24" / 61cm.

REF.: 1u/pack



Código: HER022

Palanca continental.
Medida: 20" / 51cm.

REF.: 1u/pack



Código: GAN006

Repuesto palanca TNT

REF.: 1u/pack



Código: GAN005

Repuesto cromado para
Palancas TNT.

REF.: 1u/pack



Código: HER023

Repuesto palanca de fuerza 1/2
KING TONY.

REF.: 1u/pack

**Código: HER016**

Palanca de fuerza 1/2".
 Medida: 18" / 46cm.

REF.: 1u/pack

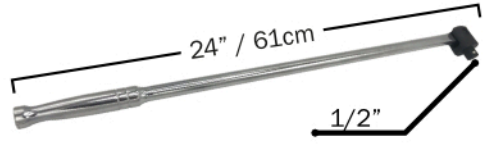
**Código: HER012**

Palanca de fuerza 1/2".
 Medida: 24" / 61cm.

REF.: 1u/pack

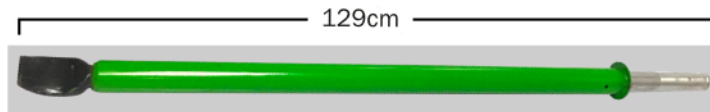
**Código: HER006**

Palanca destalonador de llantas
 Medida: 129cm a 258 cm

REF.: 1u/pack

**Código: HEN065**

destalonador de llantas OTR
 Presión: 25 - 1255 PSI

REF.: 1u/pack

**Código: HRM012**

Tanque entalonador 5gl
 Entrada de aire 1/4".

REF.: 1u/pack

**Código: HRM020**

Tanque entalonador 10gl
 Entrada de aire 1/4".

REF.: 1u/pack



Código: COM001

Comprimidor de resortes.

REF.: 1u/pack



Código: PIN001

Destalonador de llantas manual de plastico.

REF.: 1u/pack



Código: PIN002

Destalonador de llantas manual de plastico

REF.: 1u/pack



Código: HEN059

Desenllantadora portátil 220V
Aros 17.5/19.5 / 22.5



Código: HEN060

Desmontadora portátil neumático
Aros: 17.5 / 19.5 / 22.5

REF.: 1u/pack



HEAVY
DUTY

GATAS



www.lavalvula.com.ec

@lavalvulaec



Dirección: Calderón, calle Sicilia OE5-47entre Derby y Nápoles

Teléfonos: 098 664 2817 - 02 282 6285



Código: GAT027

Gata de perfil bajo doble piston.
capacidad de 3Ton.

REF.: 1u/pack



Código: GAT022

Gata BP doble piston.
capacidad de 3Ton.

REF.: 1u/pack



Código: GAT026

Gata 3Ton para talleres.
capacidad de 3Ton.

REF.: 1u/pack



Código: GAT012

Gata tipo botella 4Ton.

REF.: 1u/pack



Código: GAT013

Gata tipo botella 6 Ton.

REF.: 1u/pack



Código: GAT023

Gata tipo botella 20 Ton.

REF.: 1u/pack



Código: GAT030

Gata neumática 80 / 40Ton

REF.: 1u/pack



Código: GAT029

Gata neumática 50 / 25 Ton

REF.: 1u/pack

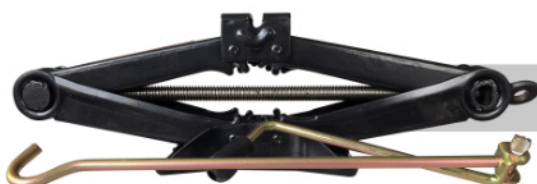

Código: GAT006

Gata tipo tijera 1.5 Ton.

REF.: 1u/pack

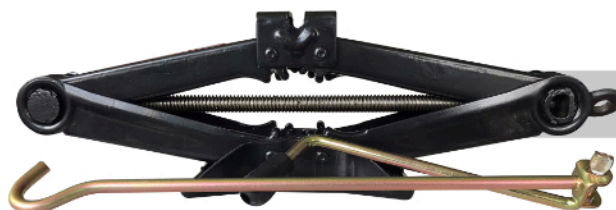

Código: GAT007

Gata tipo tijera 2 Ton.

REF.: 1u/pack



Código: GAT018

Gata BP tipo botella 30 Ton.

REF.: 1u/pack



Código: GAT016

Gata BP tipo botella 20 Ton.

REF.: 1u/pack



Código: GAT017

Gata BP tipo botella 20 Ton. Baja

REF.: 1u/pack



Código: SOP003

Soporte ajustable
de 3 Ton.

REF.: 2u/pack



Código: SOP004

Soporte ajustable
de 6 Ton.

REF.: 2u/pack



Código: GAT008

Gata portatil.
capacidad de 2Ton.
REF.: 1u/pack



Código: GAT028

Gata neumática.
capacidad de 3Ton.
REF.: 1u/pack

Relabradora HRM026-HIGH POWER



Consumo: 370 W
Regulador de temperatura: Perilla giratoria
Tamaño de cables: 1,75 m

Aumento gradual de temperatura para el mejor ajuste.
Cuenta con gran durabilidad y La más sofisticada regulación de temperatura cercana al 1%.



Relabradora HRM026 - HIGHT TECH



Tamaño de cables: 1,75 m
Regulador de temperatura: Digital
Consumo: 500 W

Teclas integradas en la parte delantera para el control de temperatura más preciso. La más sofisticada, regulación de temperatura cercana al 1% y cuenta con modo de espera cuando no está en uso.



RELABRADORAS





www.lavalvula.com.ec
[@lavalvulaec](https://www.instagram.com/lavalvulaec)
 



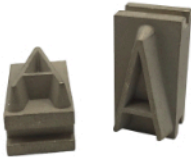

Código: HRM008

Marcador de llantas Elrick.
Voltaje: 110v -220v.
REF.: 1u/pack



Código: HRM0081

Letras por separado
Letra: A
REF.: 1u/pack

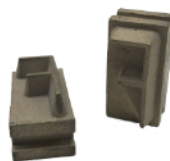

Código: HRM0081

Letras por separado
Letra: F
REF.: 1u/pack



Código: HRM0081

Letras por separado
Letra: J
REF.: 1u/pack

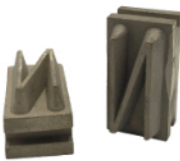

Código: HRM0081

Letras por separado
Letra: N
REF.: 1u/pack

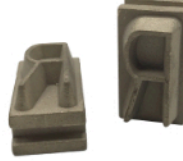

Código: HRM0081

Letras por separado
Letra: R
REF.: 1u/pack

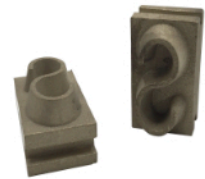

Código: HRM0081

Letras por separado
Letra: S
REF.: 1u/pack



Código: HRM0081

Letras por separado
Letra: V
REF.: 1u/pack



Código: HRM0081

Letras por separado
Letra: X
REF.: 1u/pack

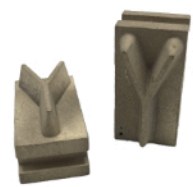

Código: HRM0081

Letras por separado
Letra: Y
REF.: 1u/pack

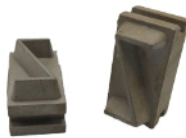

Código: HRM0081

Letras por separado
Letra: Z
REF.: 1u/pack



Código: HRM0082

Ser de letras para marcador
de llantas A-Z.
REF.: 26u/pack



Código: HRM006

Relabrador de mano Ideal Knives.

Voltaje: 110v - 120v.

Consumo: 250w.

REF.: 1u/pack



Código: HRM023

Relabrador con temperatura ajustable.

Voltaje: 220v.

Consumo: 350w.

REF.: 1u/pack



Código: CUC001

Cuchillas relabradoras.

Modelo: C1 3-5mm.

REF.: 20u/pack

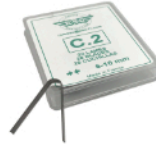

Código: CUC002

Cuchillas relabradoras.

Modelo: C2 6-10mm.

REF.: 20u/pack



Código: CUC003

Cuchillas relabradoras.

Modelo: C3 8-12mm.

REF.: 20u/pack



Código: CUC004

Cuchillas relabradoras.

Modelo: C4 10-14mm.

REF.: 20u/pack

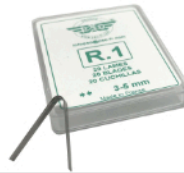

Código: CUC009

Cuchillas relabradoras.

Modelo: R1 3-5mm.

REF.: 20u/pack



Código: CUC006

Cuchillas relabradoras.

Modelo: R2 5-11mm.

REF.: 20u/pack



Código: CUC007

Cuchillas relabradoras.

Modelo: R3 7-13mm.

REF.: 20u/pack



Código: CUC008

Cuchillas relabradoras.

Modelo: R4 16-19mm.

REF.: 20u/pack



Código: CAM001

Camilla grande de 4 ruedas con almohadilla.

REF.: 1u/pack

CAMILLAS



Código: CAM002

Camilla grande de 6 ruedas con linterna y almohadilla.

REF.: 1u/pack

O - RINGS

Código: ORG003

O-Ring224T 1300/1400-24

Diam 6.84mm

REF.: 1u/pack

Código: ORG002

O-Ring225T 15.5/17.5X25

Diam 6.84mm

REF.: 1u/pack

Código: ORG001

O-Ring 20/23/25-26.5x25

25" Diam 9.78mm

REF.: 1u/pack

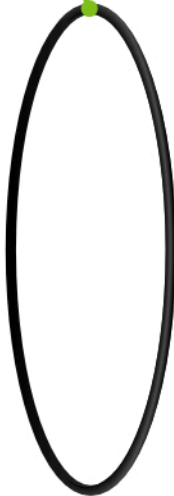
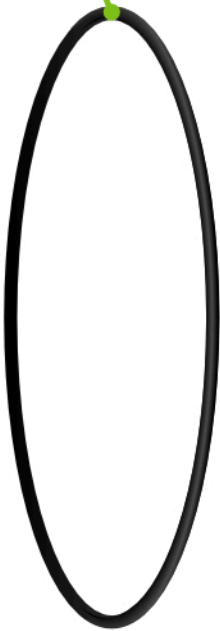

Guantes de seguridad

CÓDIGO: EPP001

Guantes de seguridad
Talla: M



CÓDIGO: EPP002

Guantes de seguridad
Talla: L



CÓDIGO: EPP003

Guantes de seguridad
Talla: S



PISTOLAS Y DADOS DE IMPACTO



www.lavalvula.com.ec

@lavalvulaec



Dirección: Calderón, calle Sicilia OE5-47 entre Derby y Nápoles

Telefonos: 098 664 2817 - 02 282 6285

DADOS 1/2" 12 CARAS



| Código | Medida |
|---------|--------------|
| 9788795 | 1/2" - 23 mm |
| 9788793 | 1/2" - 21 mm |
| 9788791 | 1/2" - 19 mm |
| 9788789 | 1/2" - 17 mm |
| 9788788 | 1/2" - 16 mm |
| 9786547 | 1/2" - 15 mm |
| 9786546 | 1/2" - 14 mm |
| 9786545 | 1/2" - 13 mm |
| 9786543 | 1/2" - 11 mm |
| 9786542 | 1/2" - 10 mm |
| 9786540 | 1/2" - 8 mm |

DADOS 1/2" 6 CARAS



| Código | Medida |
|---------|--------------|
| 9788746 | 1/2" - 24 mm |
| 9788745 | 1/2" - 23 mm |
| 9788743 | 1/2" - 21 mm |
| 9788741 | 1/2" - 19 mm |
| 9788739 | 1/2" - 17 mm |
| 9788738 | 1/2" - 16 mm |
| 9786515 | 1/2" - 15 mm |
| 9786514 | 1/2" - 14 mm |
| 9786512 | 1/2" - 12 mm |
| 9786511 | 1/2" - 11 mm |
| 9786510 | 1/2" - 10 mm |
| 9786508 | 1/2" - 8 mm |

LLAVES CON RATCHET



| Código | Medida |
|---------|--------|
| 9791986 | 19 mm |
| 9791982 | 18 mm |
| 9791984 | 17 mm |
| 9791976 | 12 mm |
| 9791974 | 10 mm |

LLAVE BOCA CORONA



| Código | Medida |
|---------|--------|
| 9786866 | 21 mm |
| 9786864 | 19 mm |
| 9786863 | 18 mm |
| 9786861 | 16 mm |
| 9786860 | 15 mm |
| 9786857 | 12 mm |
| 9786856 | 11 mm |
| 9786853 | 8 mm |

LLAVE MIXTA ANTIDESLIZANTE



| Código | Medida |
|-----------|--------|
| STMT72818 | 21 mm |
| STMT72816 | 19 mm |
| STMT72814 | 17 mm |
| STMT72812 | 15 mm |
| STMT72811 | 14 mm |
| STMT72809 | 12 mm |
| STMT72808 | 11 mm |
| STMT72807 | 10 mm |

SET DE HERRAMIENTAS 150 PIEZAS

CÓDIGO: R99-150LA



| Pcs. | Pieza |
|------|--|
| 9 | Dados largos de 6c mando 1/4": 4, 5, 6, 7, 8, 9, 10, 11 Y 12mm |
| 11 | Dados normales de 6c mando 1/4" métricos: 4, 5, 5.5, 6, 6.5, 7, 8, 9, 10, 11 y 12mm |
| 7 | Dados punta torx de seguridad mando de 1/4": T10, 15, 20, 25, 27, 30, 40 |
| 7 | Dados punta torx mando de 1/4": T10, 15, 20, 25, 27, 30, 40 |
| 2 | Extensiones mando de 1/4: 2" y 4" |
| 1 | Junta Universal mando de 1/4" |
| 1 | Adaptador de puntas mando de 1/4" |
| 1 | Mango tipo destornillador mando de 1/4" |
| 1 | Ratchet mando 1/4" con mango ergonómico |
| 8 | Dados Torx hembra mando de 3/8": E8, 10, 11, 12, 14, 16, 18 y 20 |
| 10 | Dados largos de 6 c mando de 3/8" métrico: 8, 9, 10, 11, 12, 13, 14, 15, 17 y 19mm |
| 12 | Dados normales de 6 c mando de 3/8" métricos: 8, 9, 10, 11, 12, 13, 14, 15, 16, 17, 18 y 19mm |
| 2 | Dados para bujías de 6 c mando de 3/8" de 16mm y 21mm |
| 2 | Extensiones mando de 3/8" de 3" y 10" |
| 1 | Ratchet mando 3/8" con mango ergonómico |
| 1 | Junta universal mando de 3/8" |
| 8 | daptador de puntas mando de 3/8": <ul style="list-style-type: none"> Puntas de destornillador tipo Estándar de 3mm, 4mm, 5mm, y 6mm Puntas de destornillador tipo Phillips #1 y #2. Puntas de destornillador tipo Phillips Pozidrive #1 y #2 |
| 7 | Dados Punta Torx de seguridad mando de 3/8": T-10H, T-15H, T-20H, T-25H, T-27H, T-30H, T-40H |
| 1 | Adaptador reductor de 3/8"H a 1/4"M. |
| 1 | Adaptador expansor de 3/8"H a 1/2"M |
| 4 | Dados de impacto de 6 puntas mando de 1/2" métricos 17mm, 19mm, 21mm y 23 mm |
| 11 | Dados de 6 c mando de 1/2" métricos: 14, 17, 18, 19, 20, 21, 22, 24, 27, 30 y 32 mm |
| 9 | Dados Largos 6 c mando de 1/2" métricos: 12, 13, 14, 15, 17, 18, 19, 21 y 22mm |
| 1 | Ratchet mando de 1/2" con mango ergonómico |
| 2 | Extensiones mando de 1/2" de 5" y 10" |
| 1 | Junta Universal mando 1/2" |
| 1 | Adaptador reductor de 1/2" a 3/8" |
| 10 | Llaves de combinación de acabado cromado pulido 8, 9, 10, 11, 12, 13, 14, 17, 18 y 19mm |
| 3 | Llaves de combinación tipo Ratchet 12, 13, y 14mm |
| 9 | Llaves hexagonales largas métrica 1.5, 2, 2.5, 3, 4, 5, 6, 8, y 10 |
| 1 | Alicate de combinación tipo Ford o de chofer de 8" |
| 1 | Alicate de punta de 6" |
| 1 | Destornillador Phillips #2 x 38mm |
| 1 | Destornillador Estándar 6mm x 45mm |
| 1 | Destornillador reforzado Phillips #2 x 100mm |
| 1 | Destornillador reforzado Estándar 6mm x 100mm |



Código: STMT66676-840

Juego de 10 destornilladores
CUSHIONGRIP

REF.: 10pcs/pack



Código: STMT66675-840

Juego de 8 destornilladores
CUSHIONGRIP

REF.: 8pcs/pack



Código: 0484023

Alicate electricista mango negro

REF.: 1u/pack



Código: 0484098

Playo común articulado

REF.: 1u/pack



Código: 0484122

Alicate punta chata 5"

REF.: 1u/pack



Código: 9789191

Dado punta hexagonal corto
1/2" x 12mm.

REF.: 1u/pack



Código: 9786406

Extensión 1/2 x 2.5" 62mm

REF.: 1u/pack



Código: 9786408

Extensión 1/2 x 10" 254mm.

REF.: 1u/pack



Código: 6028081

Espátula 2" - 50mm
mango plástico.

REF.: 1u/pack



Código: 95IB-84371

Alicate de presión recto 10"

REF.: 1u/pack



Código: 9794662

Juego de dados negros cromados
con ratchet 1/2"

REF.:30pcs/pack



®



Calderon, Urb. Sierra Hermosa No 1
Sicilia OE5-47 y Nápoles Quito - Ecuador
Telf.: (+593) 02-2826285 / 0986642817
www.lavalvula.com.ec
f @lavalvulaec

